

IC-SHELVING HARDWARE LIST

#10 - 5/8" WOOD SCREW-BLK



1010543

IC shelves and back cushions.

10-32 INSERT W LIP, ZINC



1010572

IC shelves and back cushions.

10-32 X1/2" MACHINE SCREW



10105622

Attach support brkt to ic-top/icperiodical

MINIFIX STUD VMI



1010609

Double ic bottom and top.

SOC SET SCREW CUP/PT 1/4-20X1



10105474

Side and back pnl brkt on backs only. Only required when backs and side pnls are used.

MINIFIX CAM UNFINISHED



1010610

IC divider and door kit. Panel used on bottom self of double faced units.

1/4-20 X 3/8 BUTTON SOC FLG SCREW-BLACK



10105470

Support brkt top and bottom frame only.

#10 - 5/8" WOOD SCREWBLK



1010543

IC shelves and back cushions.

#6-1/2" PAN HEAD PHILLIPS



1010544

IC periodical.

#8 X 1 1/2 FLT HD WD SCR



10105894

Top support channel.

1/4-20 X 1/2 BUTTON SOC FLG SCREW



10105472

Side and back panels only.

10-32 LOCKNUT-BLACK



1010545

IC periodical.

#10 FLAT WASHER



1010554

IC periodical.

1/-20 X 40M JOINT CONNECTOR BOLT BL OX



10105473

IC bottoms.

3/8" X 3" BOLT BLACK



1010100

IC frame assy.

GLIDE (ADJUSTABLE) INTUITIVE



1010558

Bottom of frame.

DOUBLE END CAP



1011043

IC double side from top section.

SINGLE END CAP



1011042

IC single side from top section.

CAGE NUT PL 1/4-20 PANEL RANGE



10105627

Bottom support bracket.

SIDE PANEL BRACKET



943115

Attach the side panel.

IC-SHELVING HARDWARE LIST

SIDE & BACK PANEL BRACKET



943116

Attach back panel and side panel

ALL TERRAIN END CAP



941586

IC frame bottom section on the shelf upright tubes.

WIRE CHANNEL-BRACKET



9431051

Used for back panel only to fasten the upright tube to the cross bars. Bend goes underneath the cross bar.

IC BACK PANEL BRACKET



9431200

Used for back panel only when there are no side panels.

1/4-20 X 3/8 BUTTON SOC FLG SCREW-ZINC



10105470

Attach top and bottom bracket to frame.

#8-3/4" BLK FLT HD CS SCR



1010589

Attach ic-side book stop to shelves and bottoms.

1/4-20 X 3/4 BUTTON SOC FLG SCREW



101054721

Used for polyclear side panels only.

OUTSIDE PANEL BRACKET



94311502

Used for polyclear side panels only

IC-SIDE BOOK STOP



943770-T

Used for IC shelves and bottom.

IC-SHELVING PARTS LIST

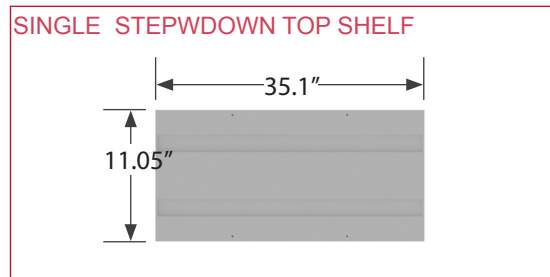
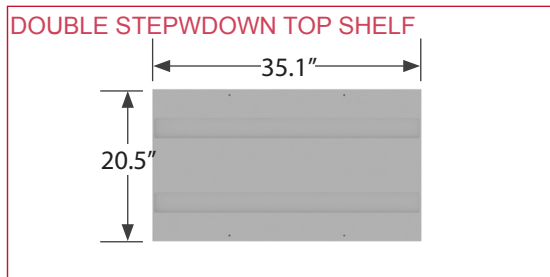
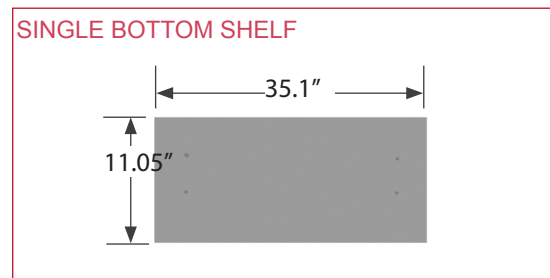
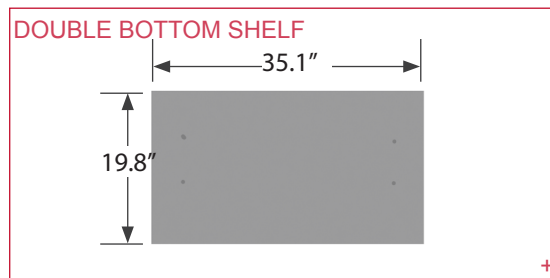
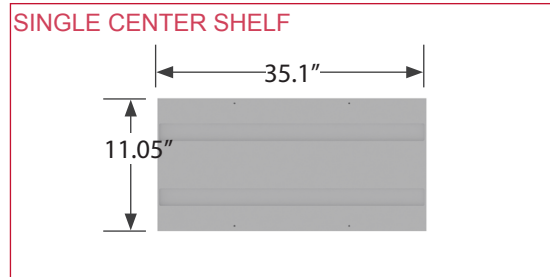
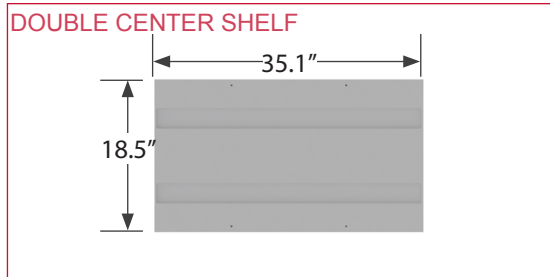
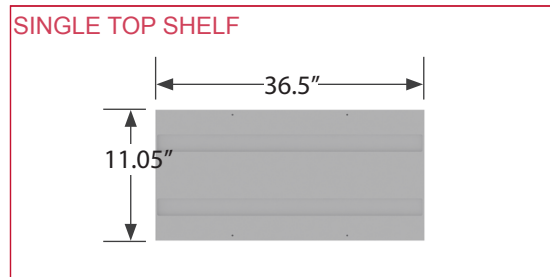
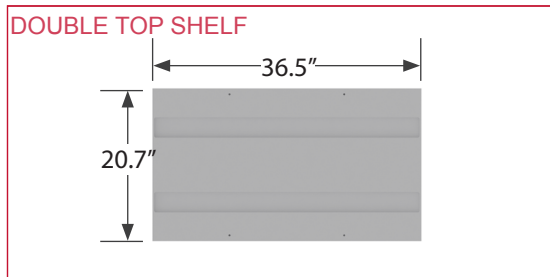
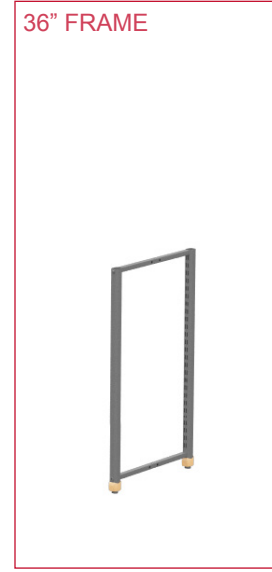
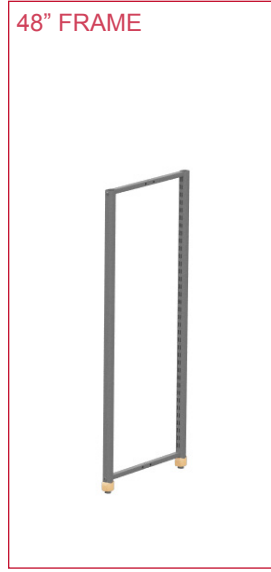
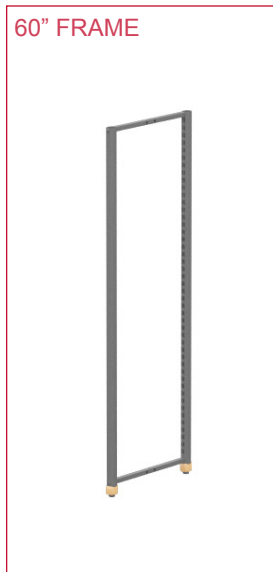
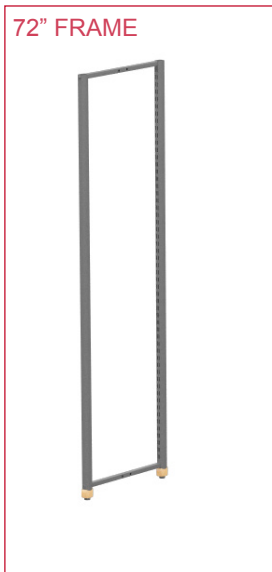

NOTE:
 MOST OF THE COMPONENTS ARE USED FOR BOTH TYPES SINGLE OR DOUBLE UNITS
 * SINGLE ONLY
 **DOUBLE ONLY

DIVIDER



NOTE
DIVIDERS ARE ONLY USED ON THE BOTTOM ONLY
ON DOUBLE UNITS

8434006

DOUBLE STEP DOWN BRACKET

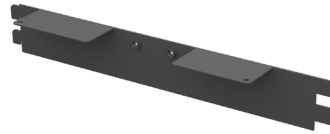

943110

SINGLE STEP DOWN BRACKET



943111

EN RUN TABLE BRACKET

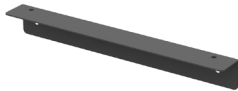

95017-B

DOUBLE EASY LOCK BRACKET

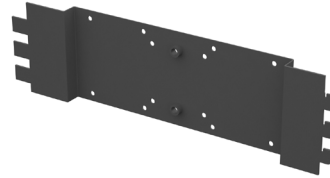

942821

SINGLE EASY LOCK BRACKET

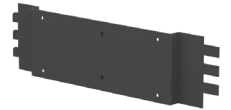

942822

TOP SUPPORT CHANNEL



943131

DOUBLE BACK CUSHION

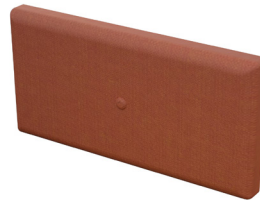

8434006

SINGLE BACK CUSHION



BOOK WIRE

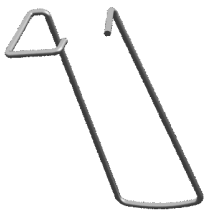

943113

WIRE CHANNEL

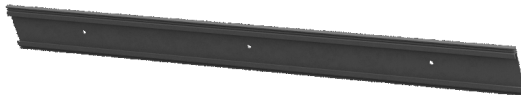

ONLY USED ON THE SINGLE UNITS INSIDE
THE METAL TOP SUPPORT

942949

TOP SUPPORT CHANNEL



943131

SUPPORT BRACKET BOTTOM TITANIUM

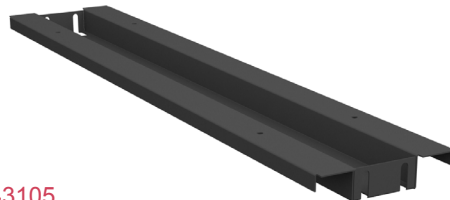

943105

SHELF BRACKET ASSEMBLY



943117

OPTIONAL

Go to page 8 for installation

BACK PANEL 72"

5.38"
4.13"

There is a top and a bottom side. A sticker shows the top part.
97320003

BACK PANEL 60"

5.38"
4.13"

There is a top and a bottom side. A sticker shows the top part.
94320002

BACK PANEL 48"

5.38"
4.13"

There is a top and a bottom side. A sticker shows the top part.
94320001

BACK PANEL 36"

5.6"
4.13"

There is a top and a bottom side. A sticker shows the top part.
94320018

SINGLE SIDE PANEL 72"

4.75" 8.5"
3.13"

There is a top and a bottom side. A sticker shows the top part.
94320103

SINGLE SIDE PANEL 60"

4.62" 8.5"
3.13"

There is a top and a bottom side. A sticker shows the top part.
4320102

SINGLESIDE PANEL 48"

4.68" 8.5"
3.13"

There is a top and a bottom side. A sticker shows the top part.
94320101

SINGLE SIDE PANEL 36"

5.13" 8.5"
3.13"

There is a top and a bottom side. A sticker shows the top part.
94320124

DOUBLE SIDE PANEL 72"

4.75" 17.12"
3.13"

There is a top and a bottom side. A sticker shows the top part.
94320106

DOUBLE SIDE PANEL 60"

4.62" 17.12"
3.13"

There is a top and a bottom side. A sticker shows the top part.
94320105

DOUBLE SIDE PANEL 48"

4.68" 17.12"
3.13"

There is a top and a bottom side. A sticker shows the top part.
94320104

DOUBLE SIDE PANEL 36"

5.13" 17.12"
3.13"

There is a top and a bottom side. A sticker shows the top part.
943830

OPTIONAL

IC-Periodicals

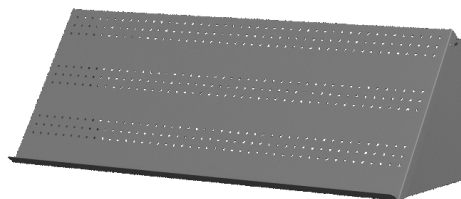

SLIDING DOOR



DOUBLE INRUN BENCH



SINGLE ENDRUN BENCH



INRUN TABLE



ENDRUN TABLE



SHELVING HARDWARE LEGEND

MODEL #	Part Number						
	1010543	10105470	10105473	942949	943113	943117	943770-T
D36	16	16	4	2	12	2	8
D48	16	16	4	2	12	4	12
D60	32	16	4	2	20	6	16
D72	32	16	4	2	20	8	20
S36	8	8	4	X	6	2	4
S48	8	8	4	X	6	4	6
S60	16	8	4	X	10	6	8
S72	16	8	4	X	10	8	10

Exploded View IC SHELVING

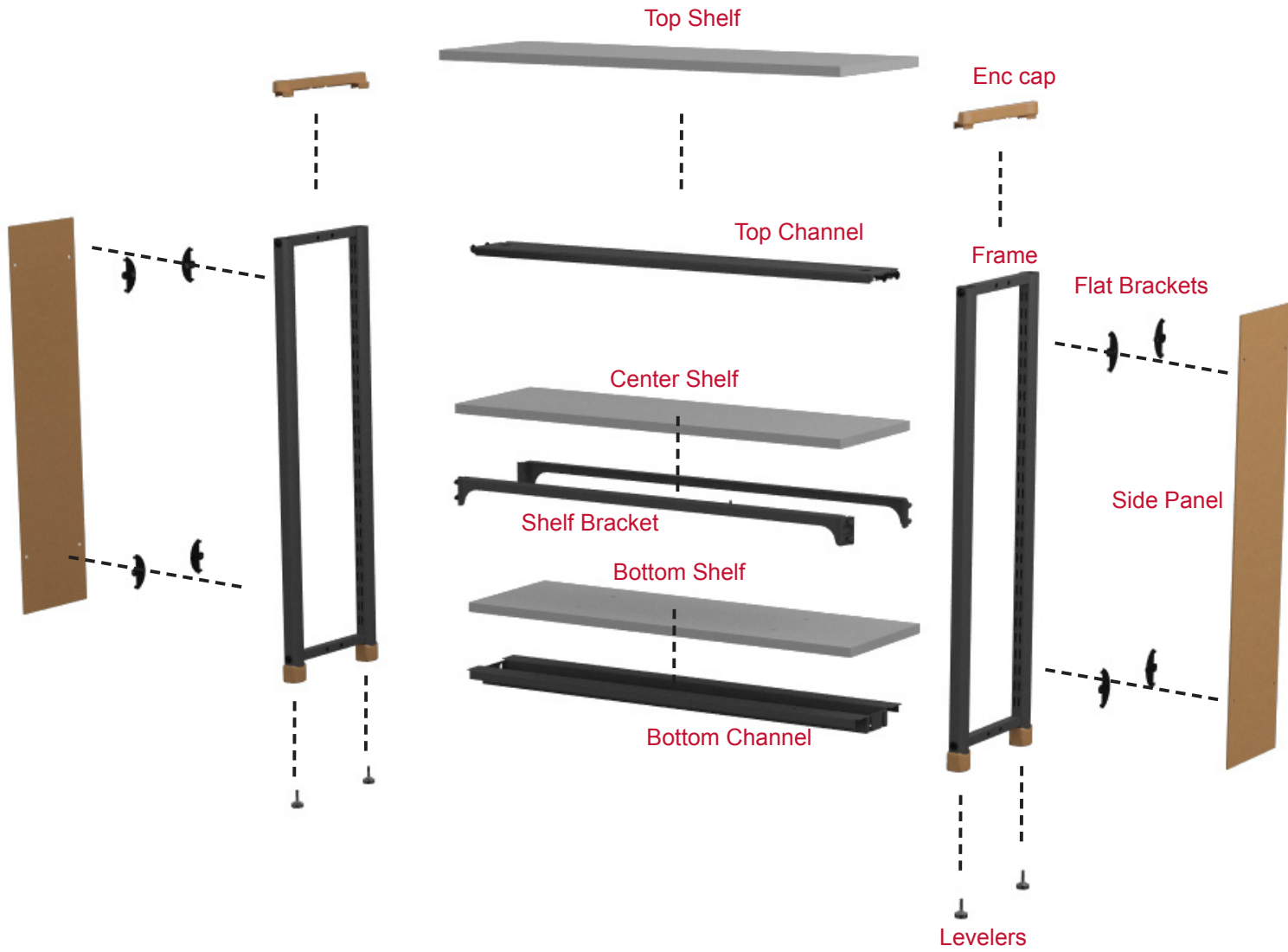

Step 1

Attach Glides to upright frames. Notice it is 5 72" frames and 1 60" frame.

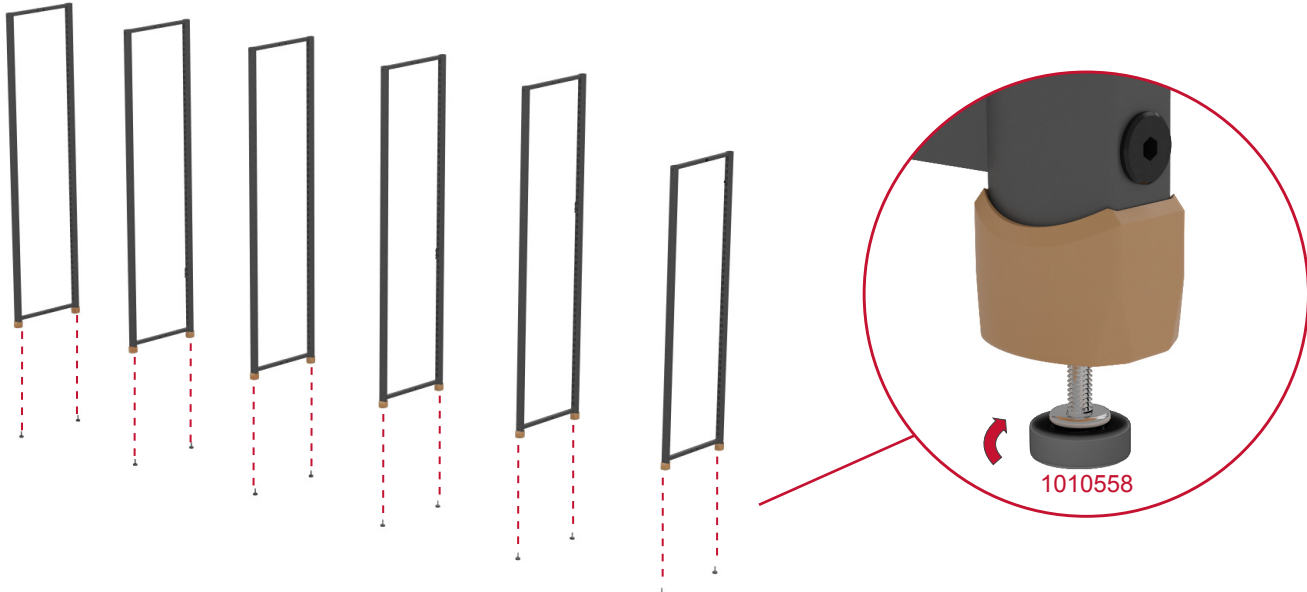

Step 2

Loosely screw in four silver pan head screws to the inside of the side upright frames.

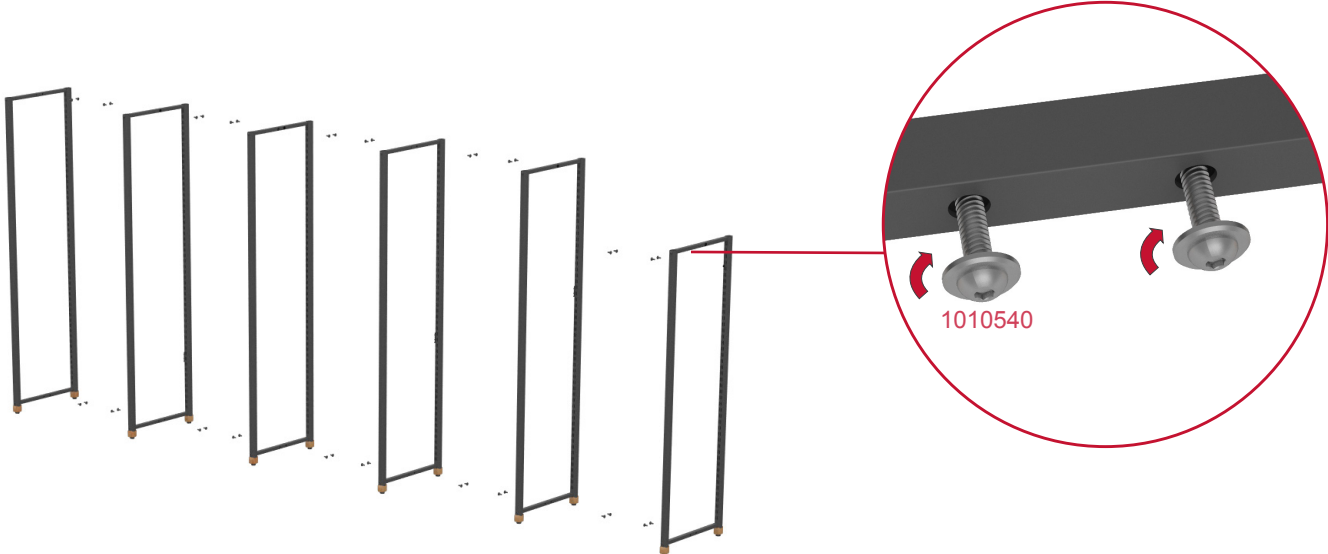

Step 3 Slide ten horizontal shelf brackets in place

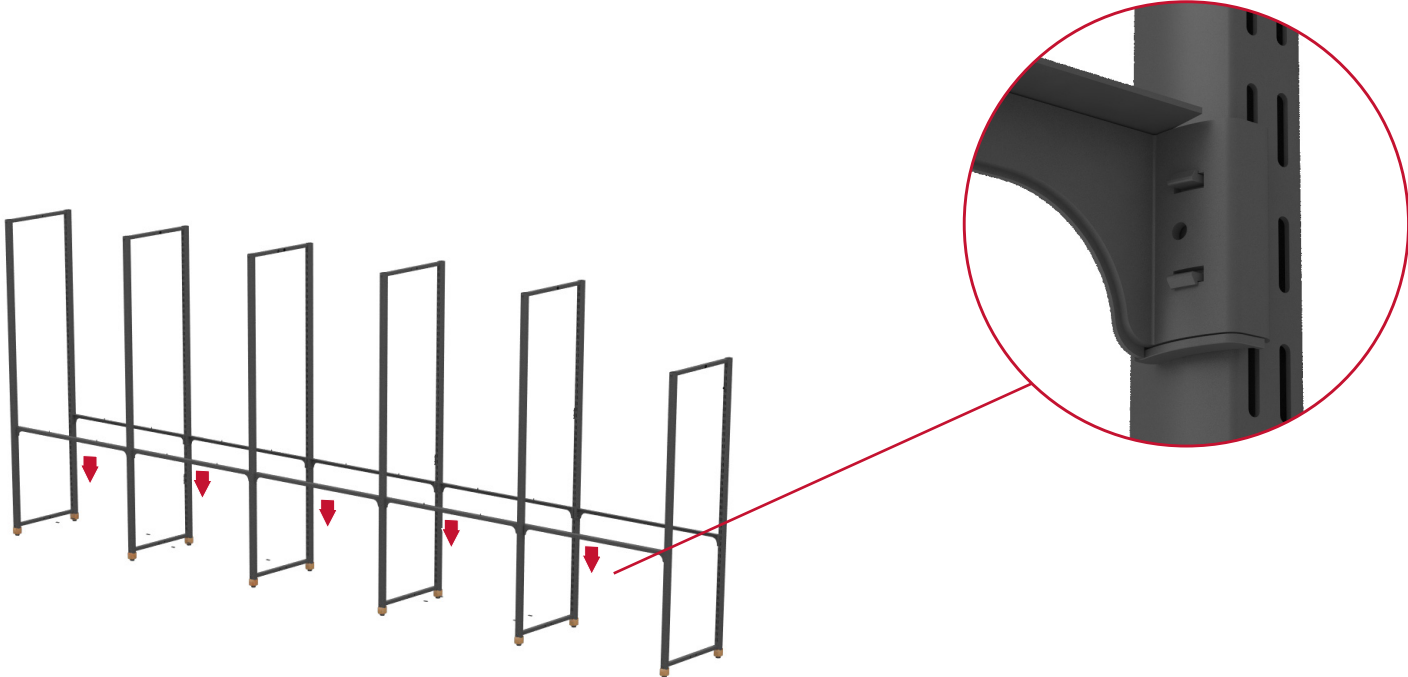

Step 4 Slide 28 horizontal shelf brackets in place.

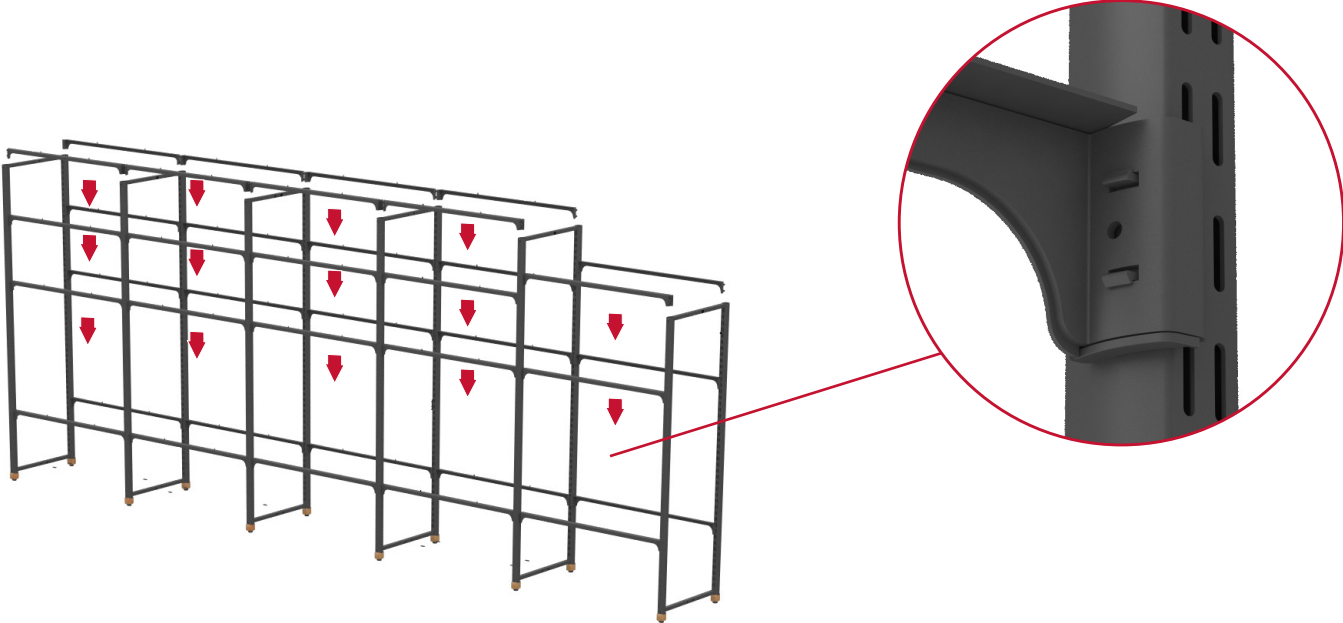

Step 5

Sit the bottom and top channels in place. Tighten pan head screws.

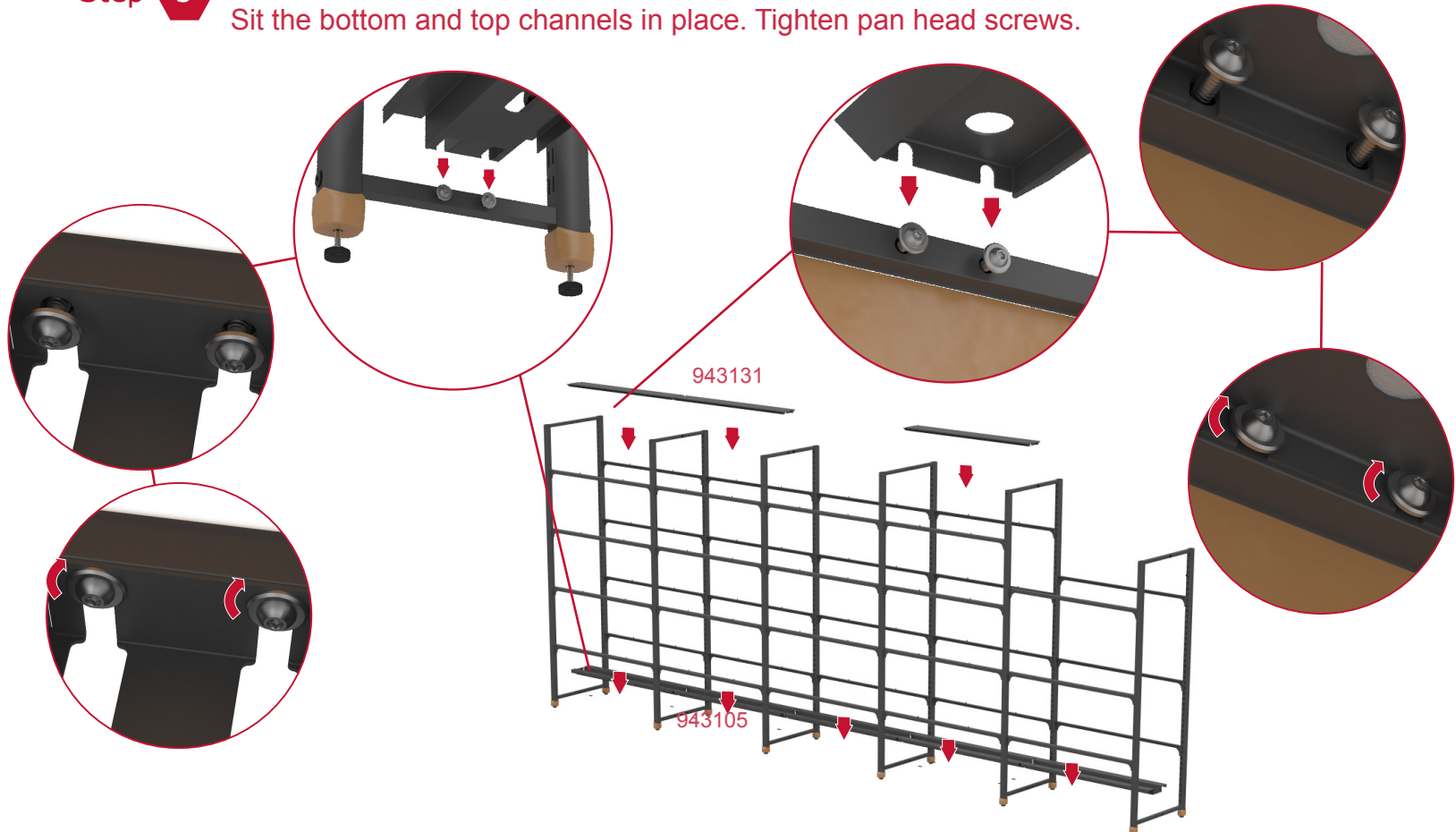

Step 6

STEP TO BE FOLLOWED **ONLY** IF YOU CHOSE TO HAVE DOUBLE SHELVING

Make sure your panel bracket is inserted into the inner slots of the side upright frames.

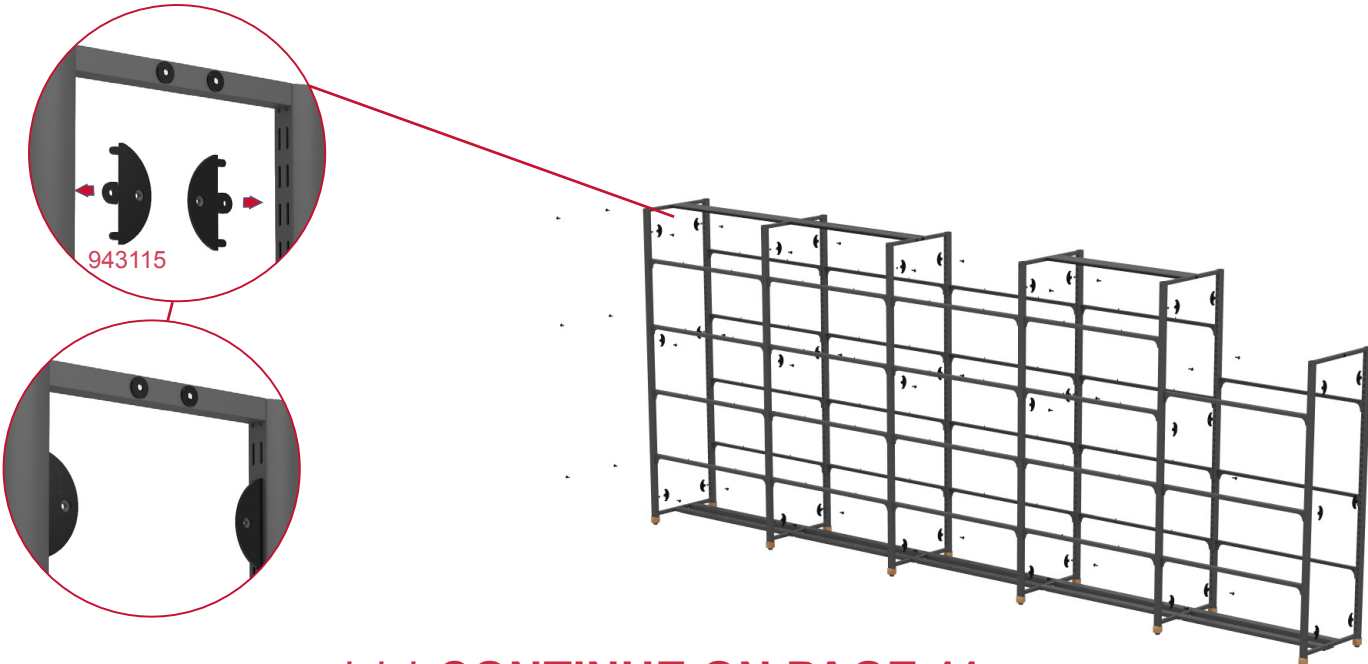

***** CONTINUE ON PAGE 11**

Step  STEP TO BE FOLLOWED **ONLY** IF YOU CHOSE TO HAVE SINGLE SHELVING
Make sure your panel bracket is inserted into the inner slots of the side upright frames.

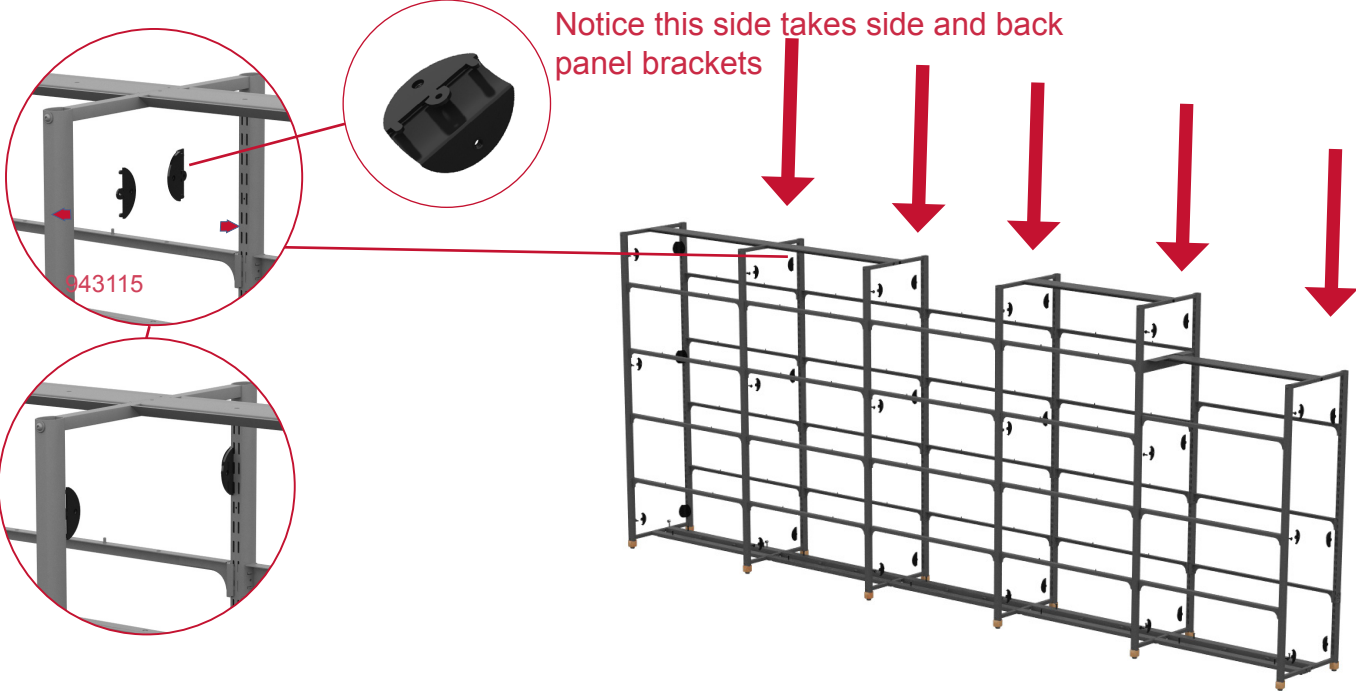

Step  STEP TO BE FOLLOWED **ONLY** IF YOU CHOSE TO HAVE SINGLE SHELVING
Attach each side panel. Look for the sticker showing which side is up on the panel. Line up with predrilled holes in panel for placement.

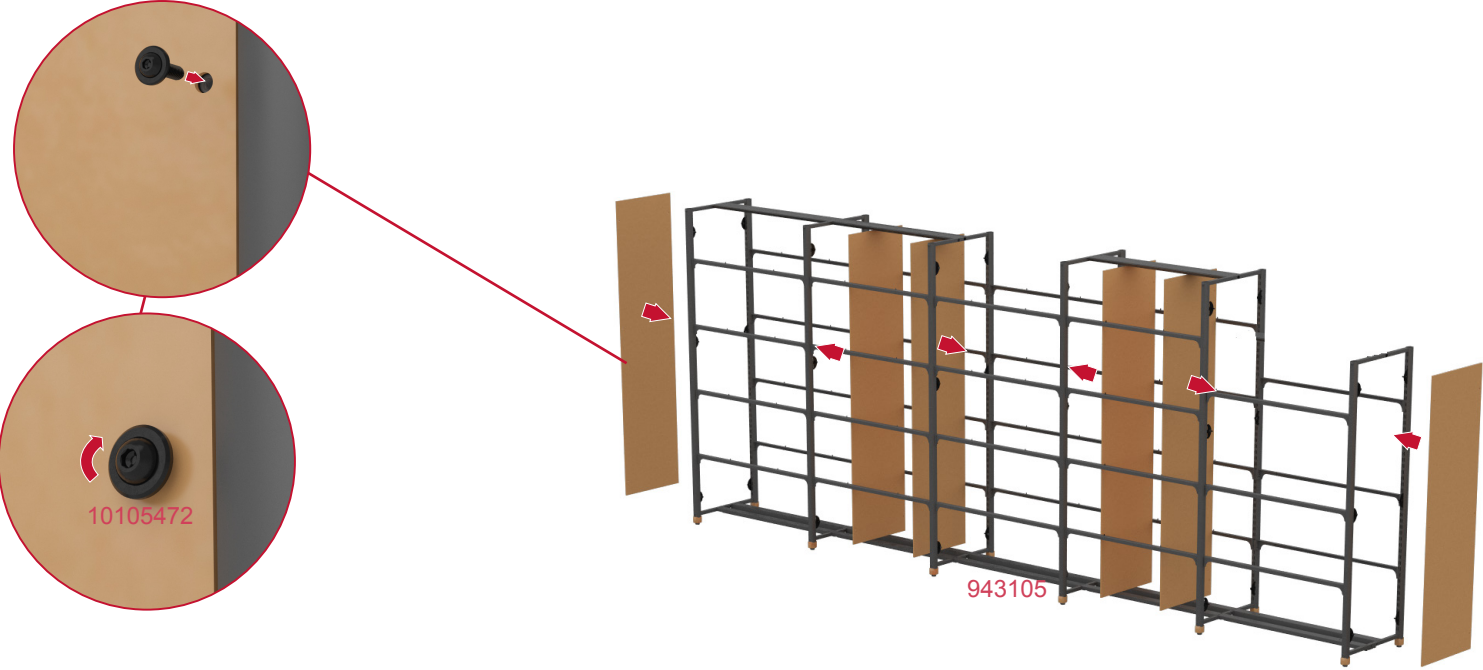

Step  STEP TO BE FOLLOWED **ONLY** IF YOU CHOSE TO HAVE SINGLE SHELVING

Attach each side and back panel brackets. Line up with predrilled holes in panel for placement. And screw bolt to attach both brackets and keeping the side panel in between.

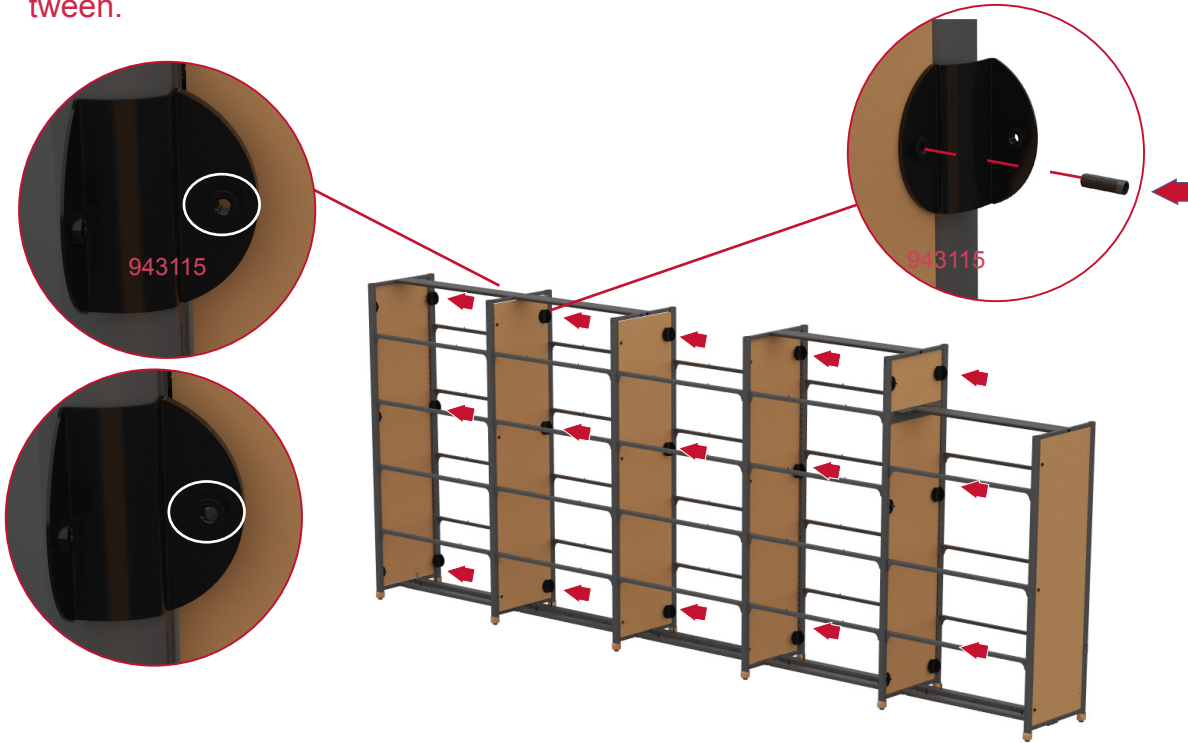

Step  STEP TO BE FOLLOWED **ONLY** IF YOU CHOSE TO HAVE SINGLE SHELVING

Attach each back panel. Look for the sticker showing which side is up on the panel. Line up with predrilled holes in panel for placement.

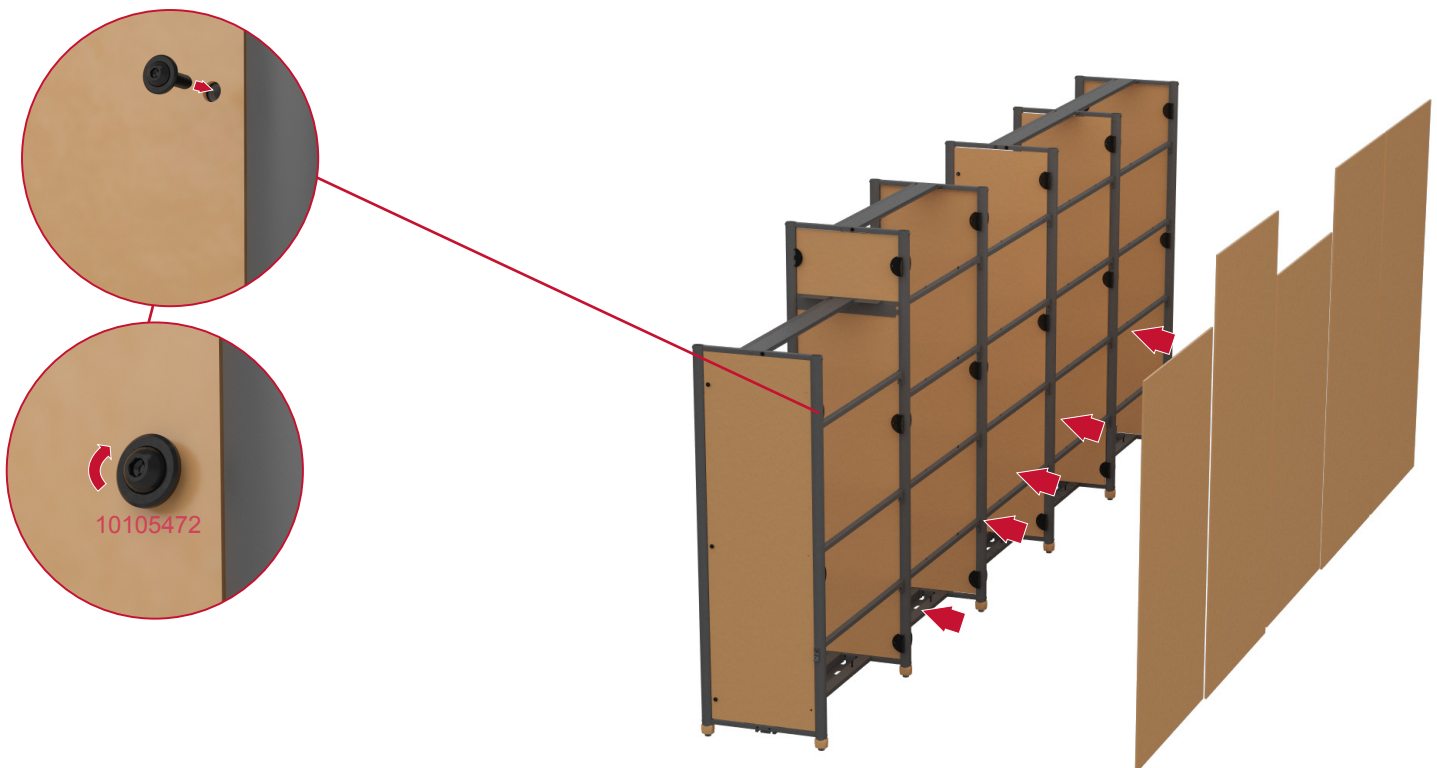

Step



STEP TO BE FOLLOWED **ONLY** IF YOU CHOSE TO HAVE SINGLE SHELVING

Single shelving unit.

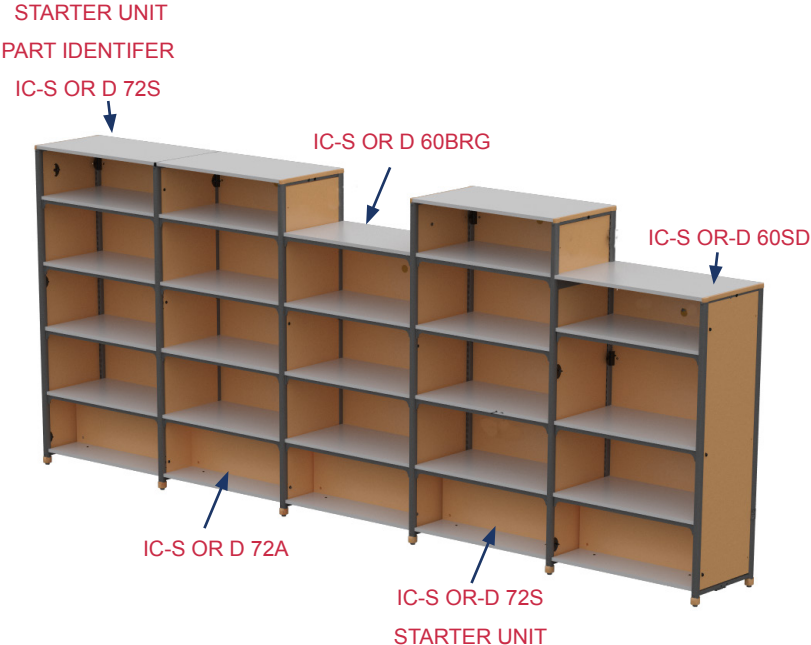

Step **7** Attach each side panel. Look for the sticker showing which side is up on the panel. Line up with predrilled holes in panel for placement.

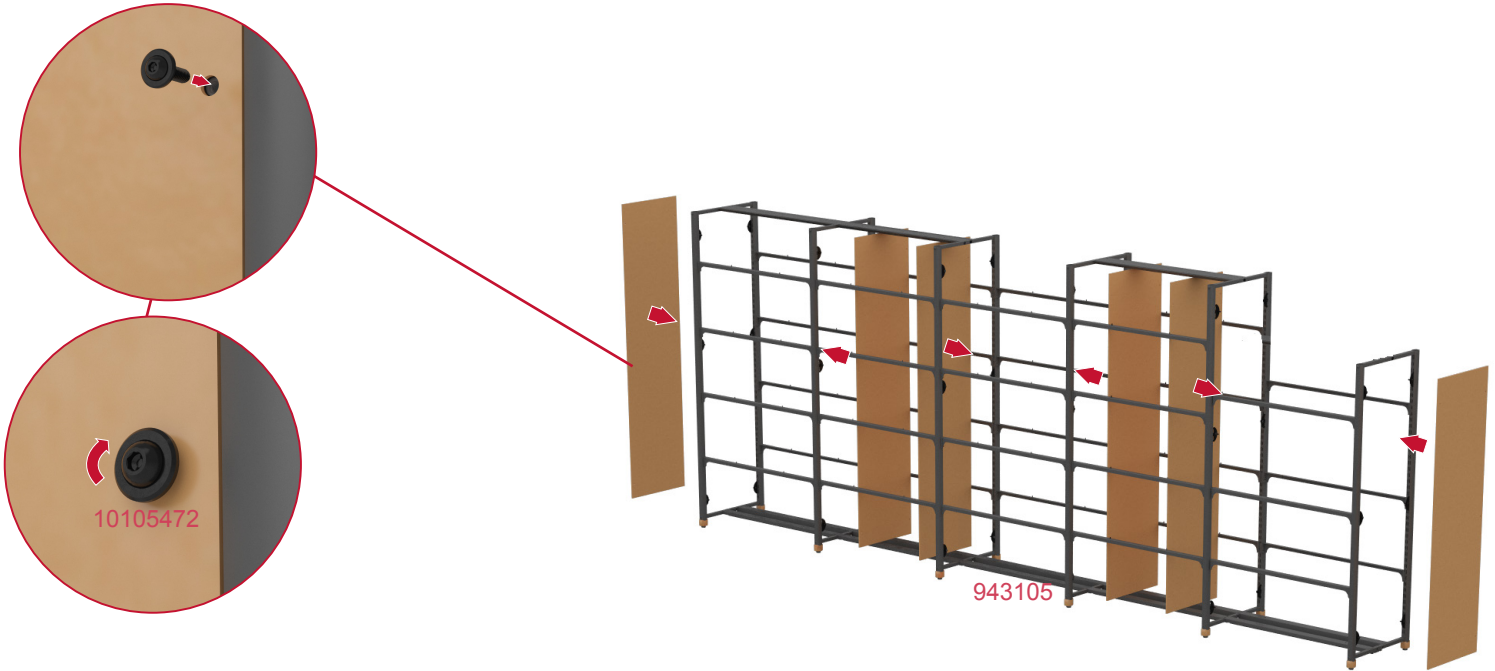

Step **8** How to install a step down bracket.

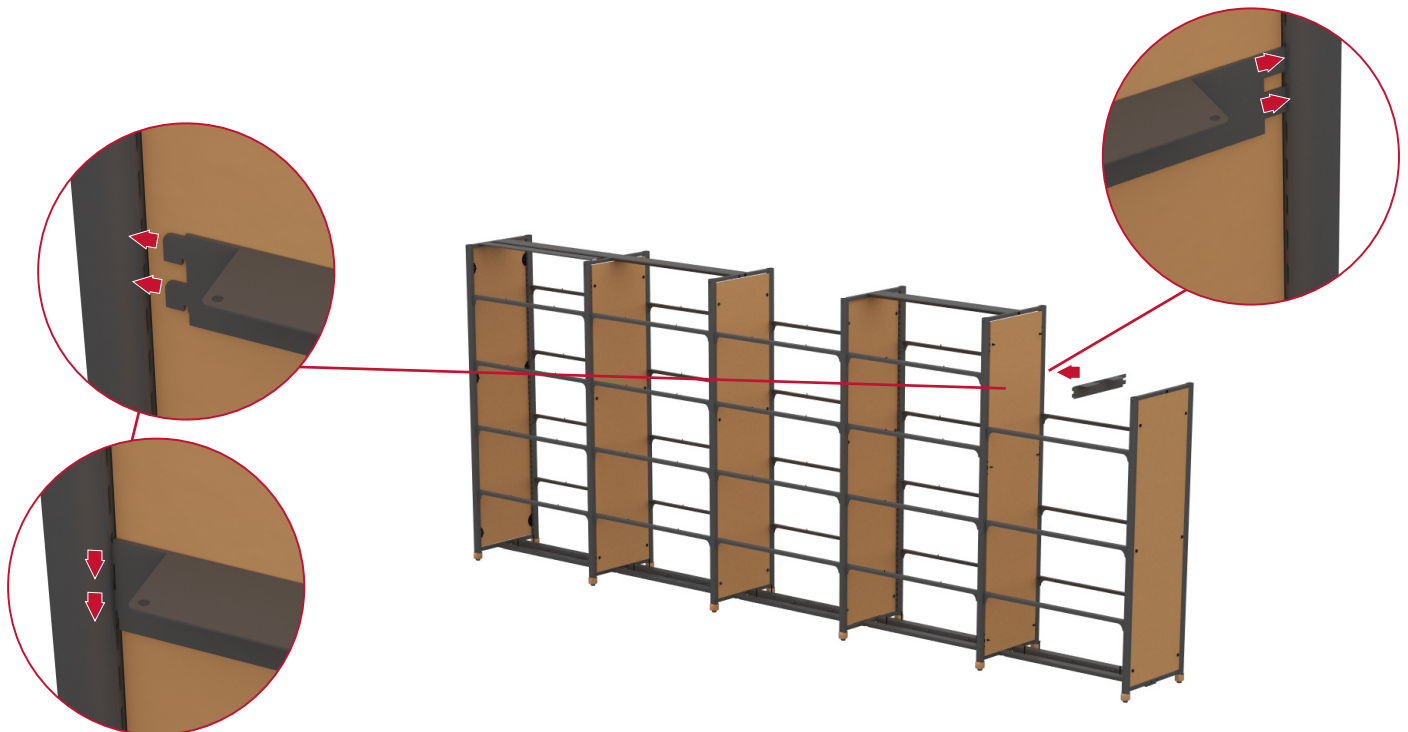

Step 9

Sit the top channel in place. Tighten pan head screws.

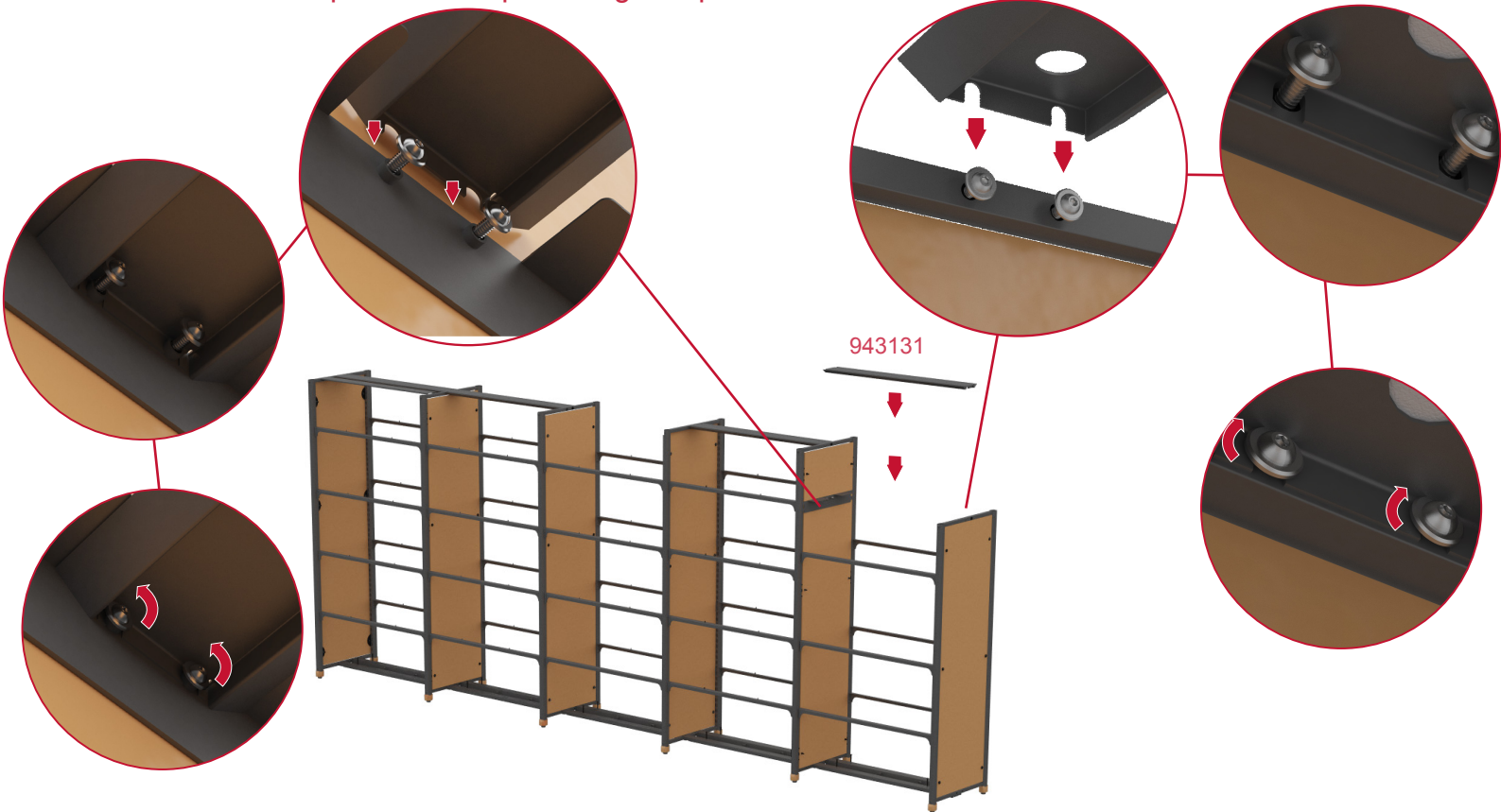

Step 10

Line up the bottom shelves with the four predrilled holes with the tinnerman nuts in bottom channel. Attach using four allen head bolts.

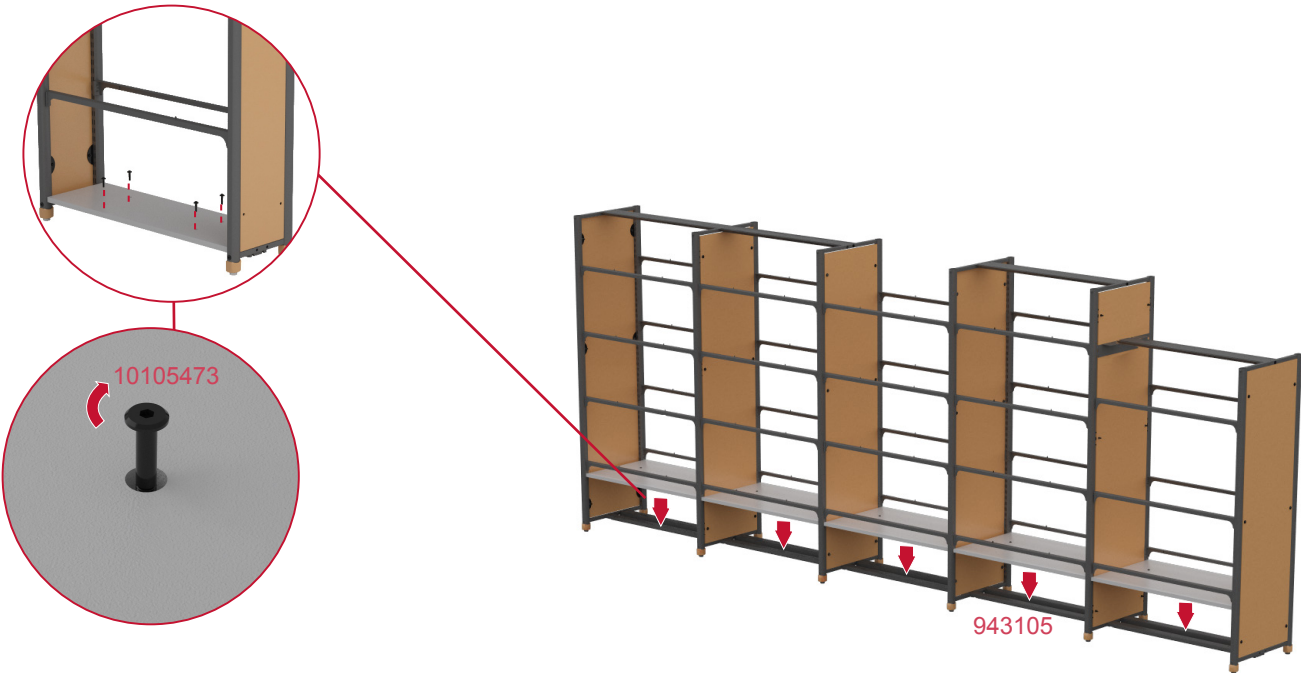

Step 11

First crew mini-fix threaded posts to the bottom shelf and Slide dividers into studs as shown.



Step 12

Place side book stops on adjustable center shelf using 2 wood screws on each.

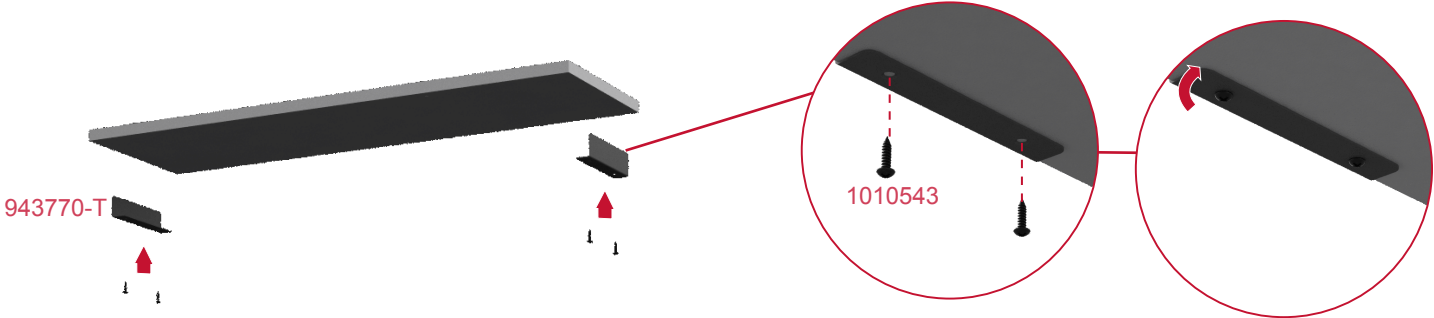

NOTE 2 Side book stops on single face units. 4 Side book stops on double face units



Step 13

Place center shelves in on top of brackets lining up guide pegs and holes and secure the shelf to the bracket with 6 wood screws in center edge of each shelf.

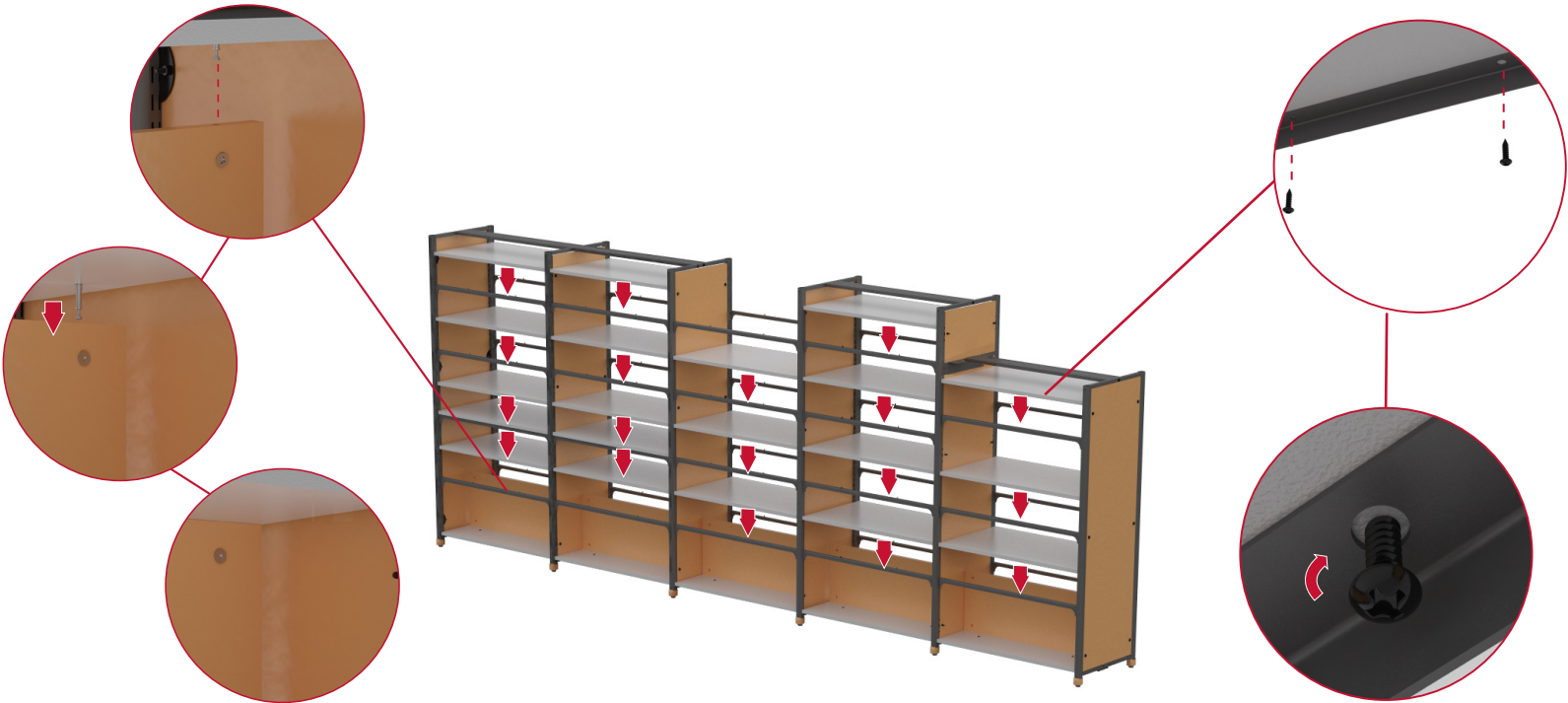

Step 14

Place end caps in place.

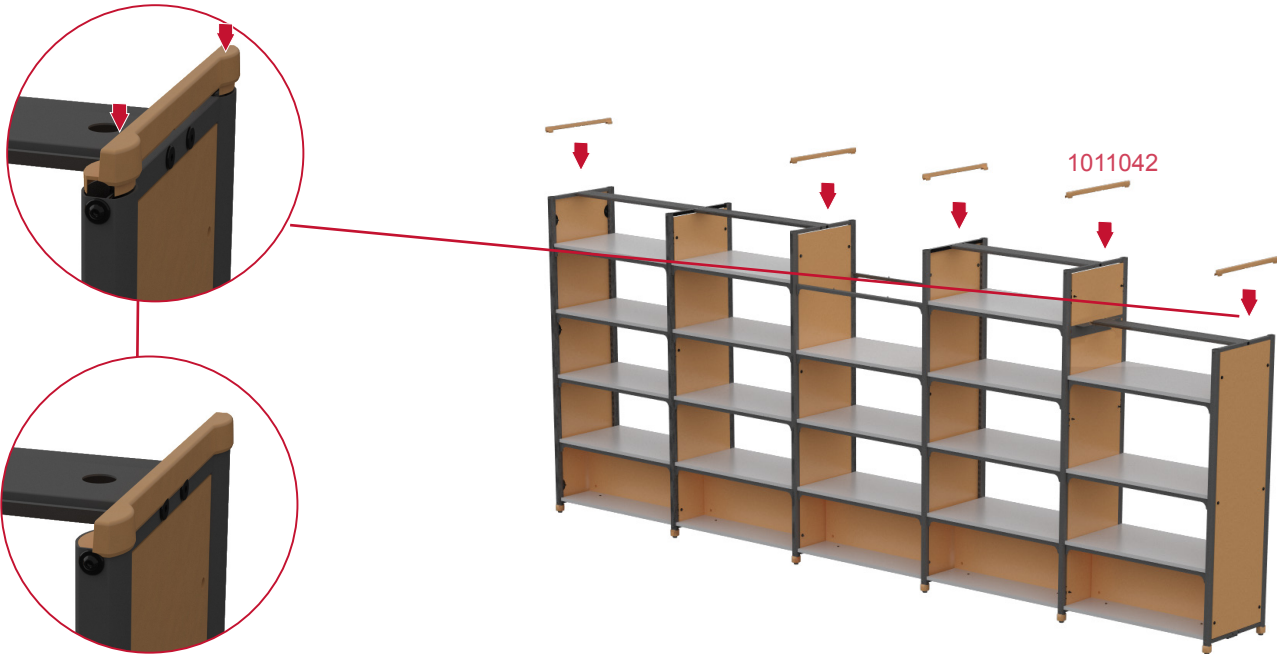

Step **15** Place top shelves on top of the top channels.

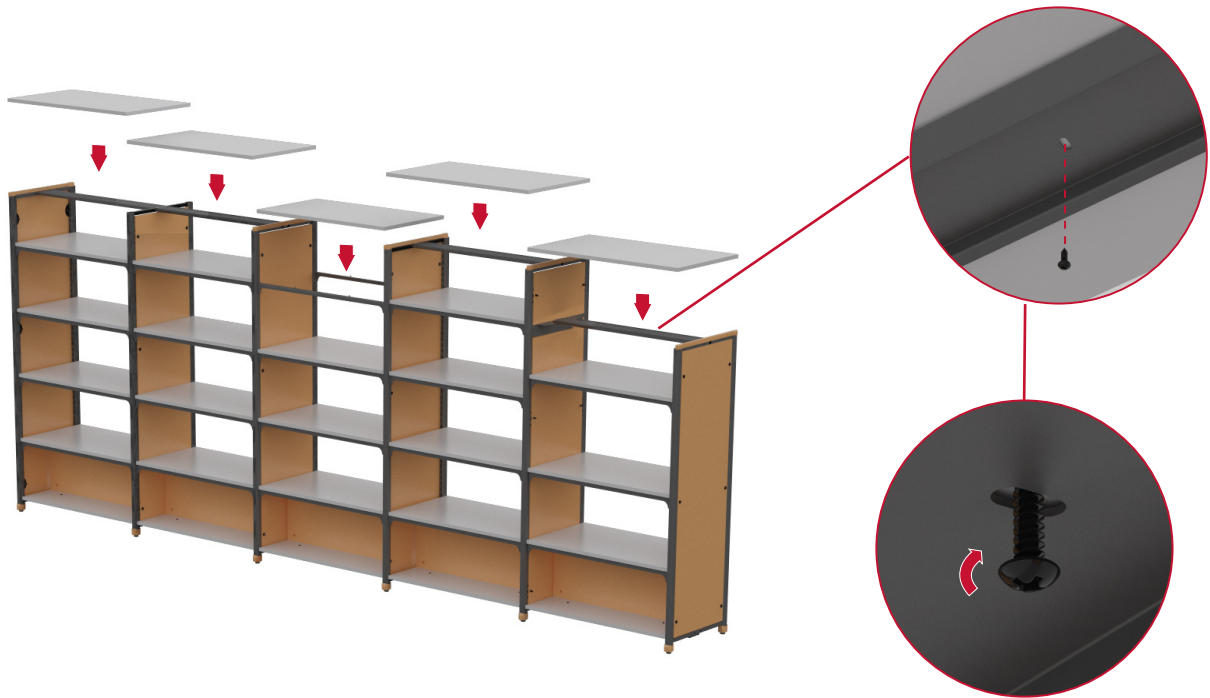

Step **16** Place top channel supports.

Step 17 Attach Glides to upright frames.

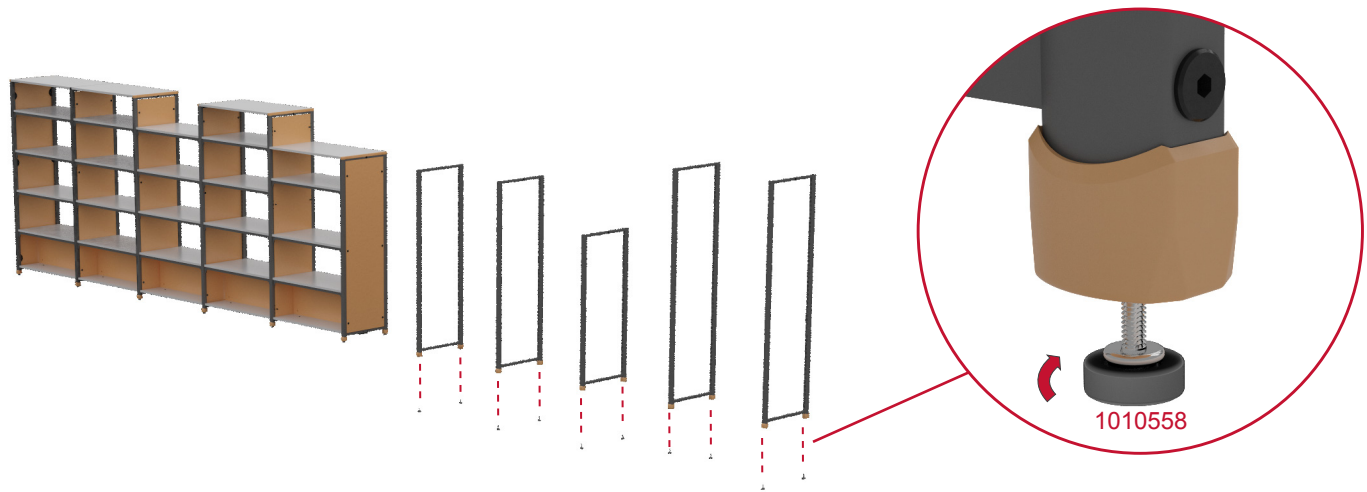

Step 18 Loosely screw in four silver pan head screws to the inside of the side upright frames.

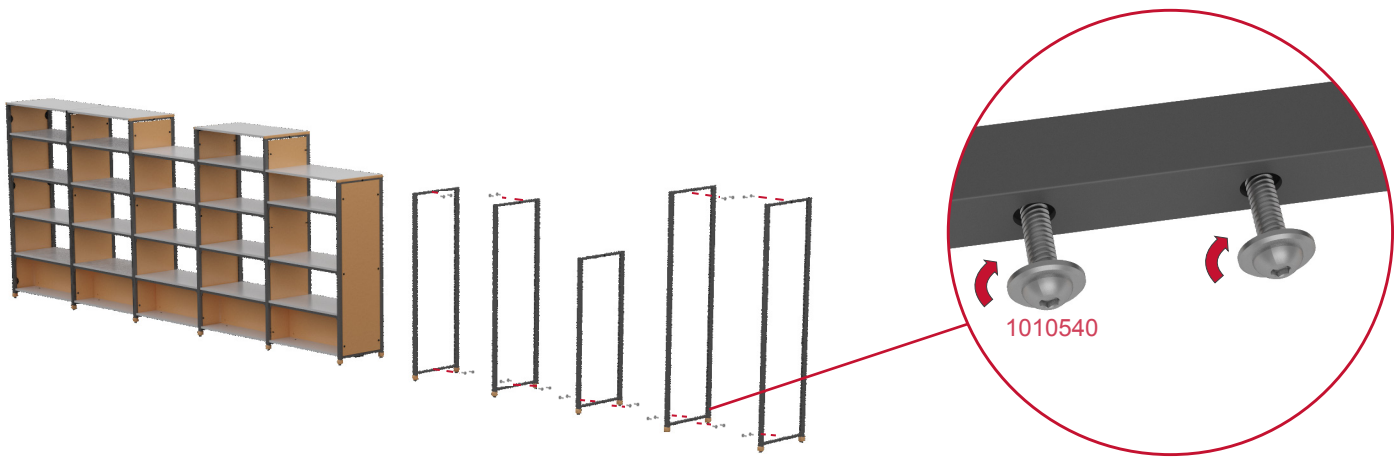

Step 19 Slide eight horizontal shelf brackets in place

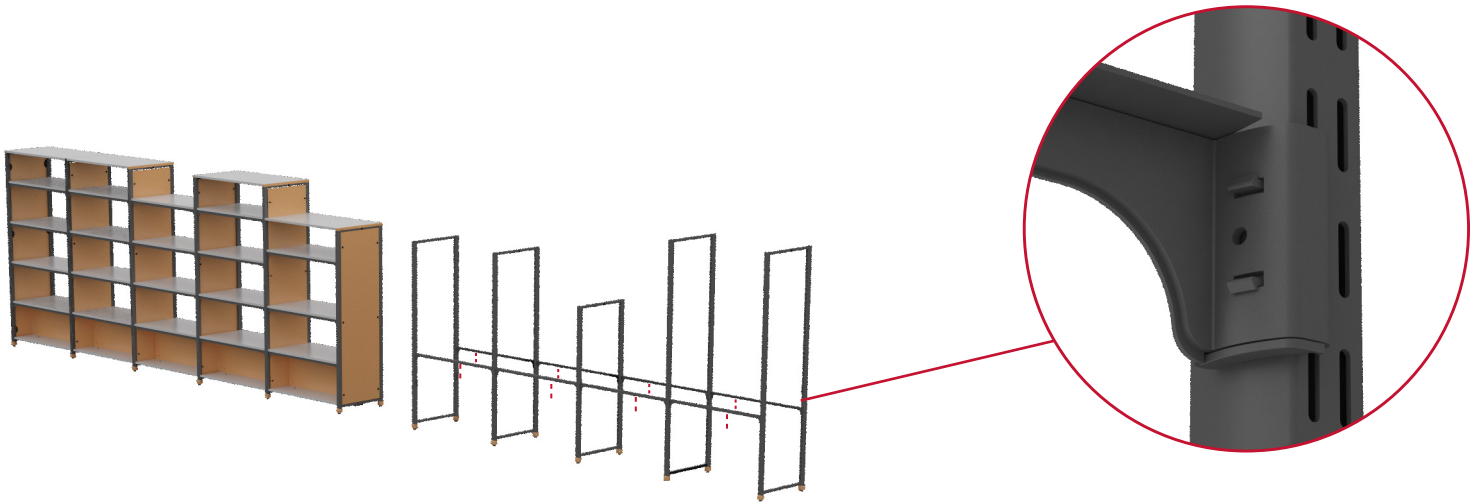

Step 20 Slide twelve horizontal shelf brackets in place

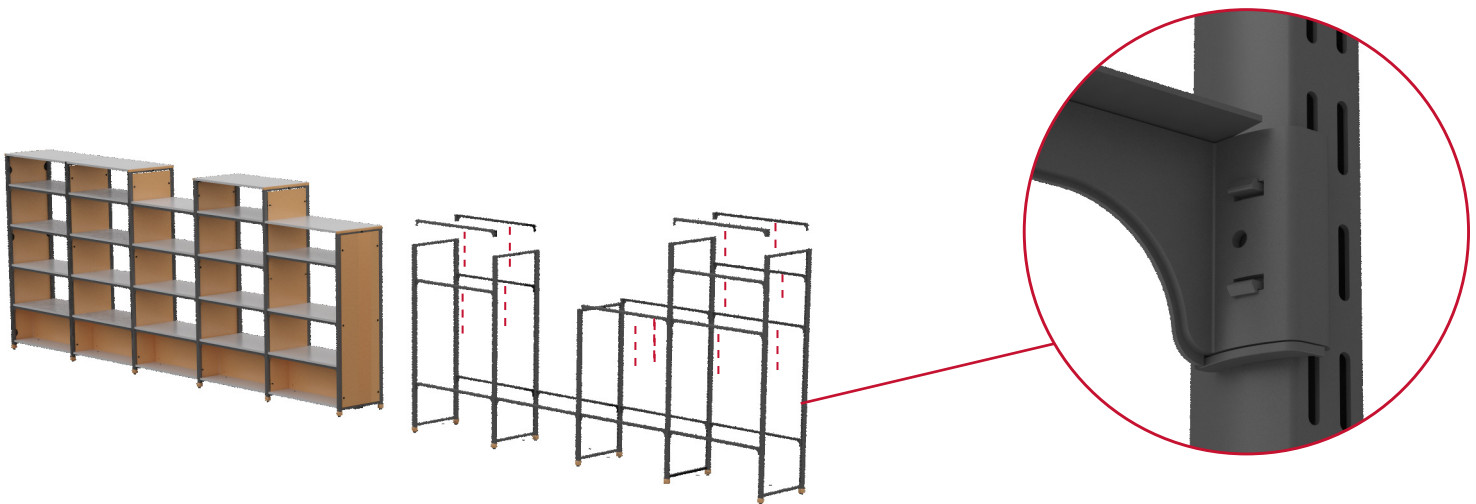

Step 21

Sit the bottom and top channels in place. Tighten pan head screws.

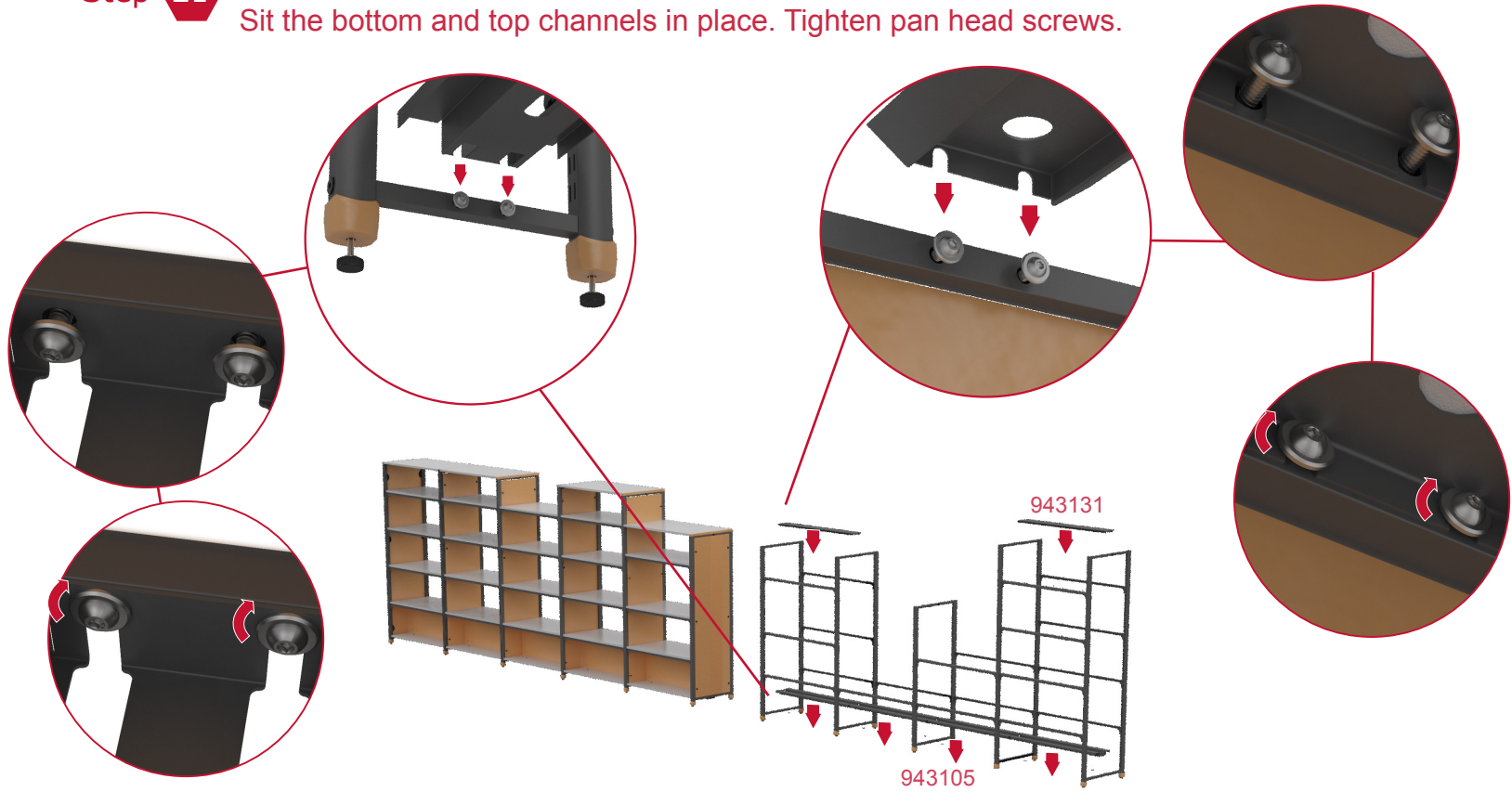

Step 22

STEP TO BE FOLLOWED **ONLY** IF YOU CHOSE TO HAVE DOUBLE SHELVING

Make sure your panel bracket is inserted into the inner slots of the side upright frames.

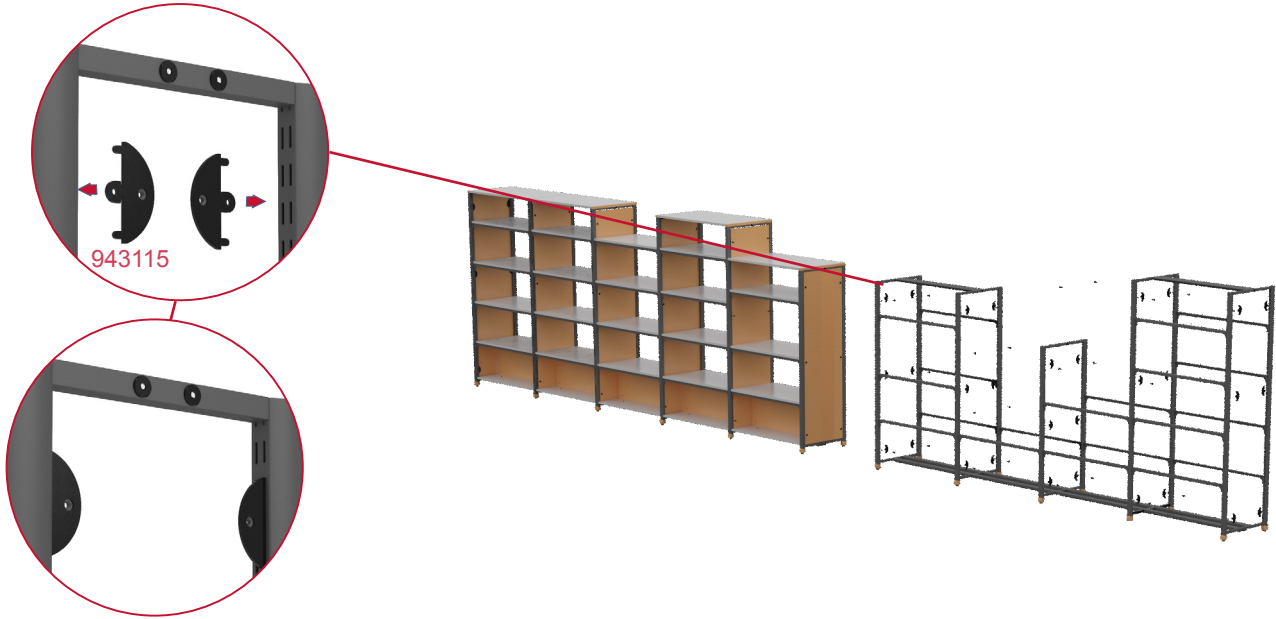

IF YOU CHOSE TO HAVE SINGLE SHELVING GO TO PAGES 8-10 FOR REFERENCE ON HOW TO ATTACH BACK PANELS.

Step 23

Attach each side panel. Look for the sticker showing which side is up on the panel. Line up with predrilled holes in panel for placement.

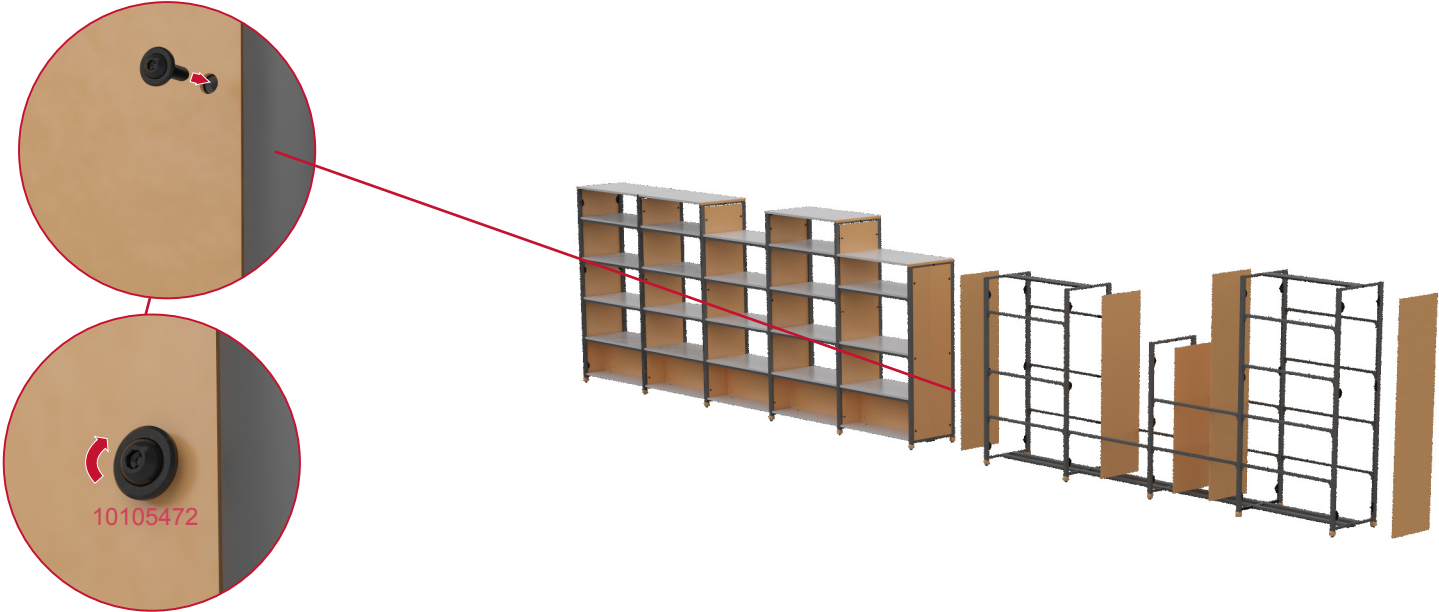

Step 24

Place step down bracket as shown.

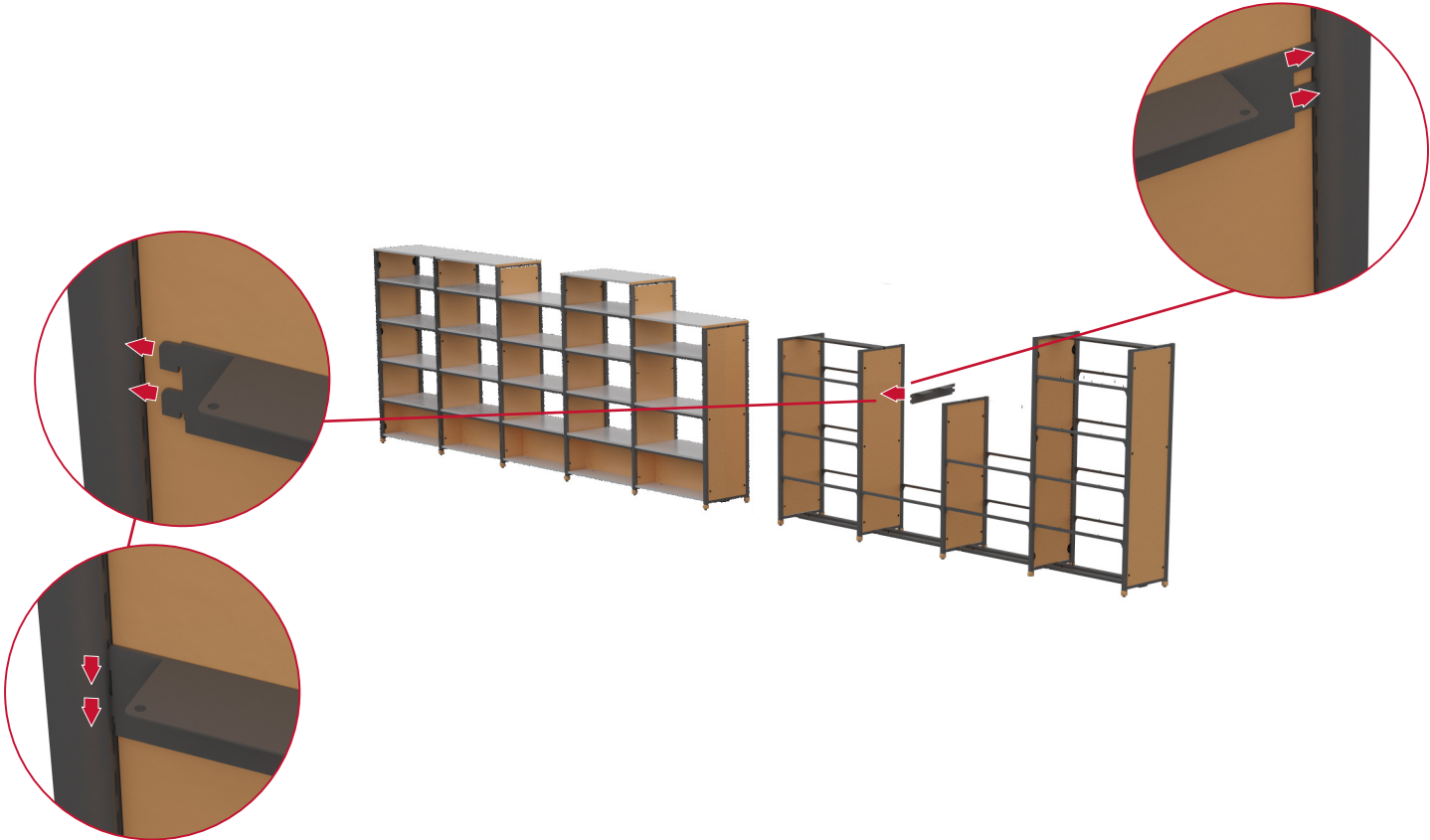

Step 25 Sit the top channel in place. Tighten pan head screws.

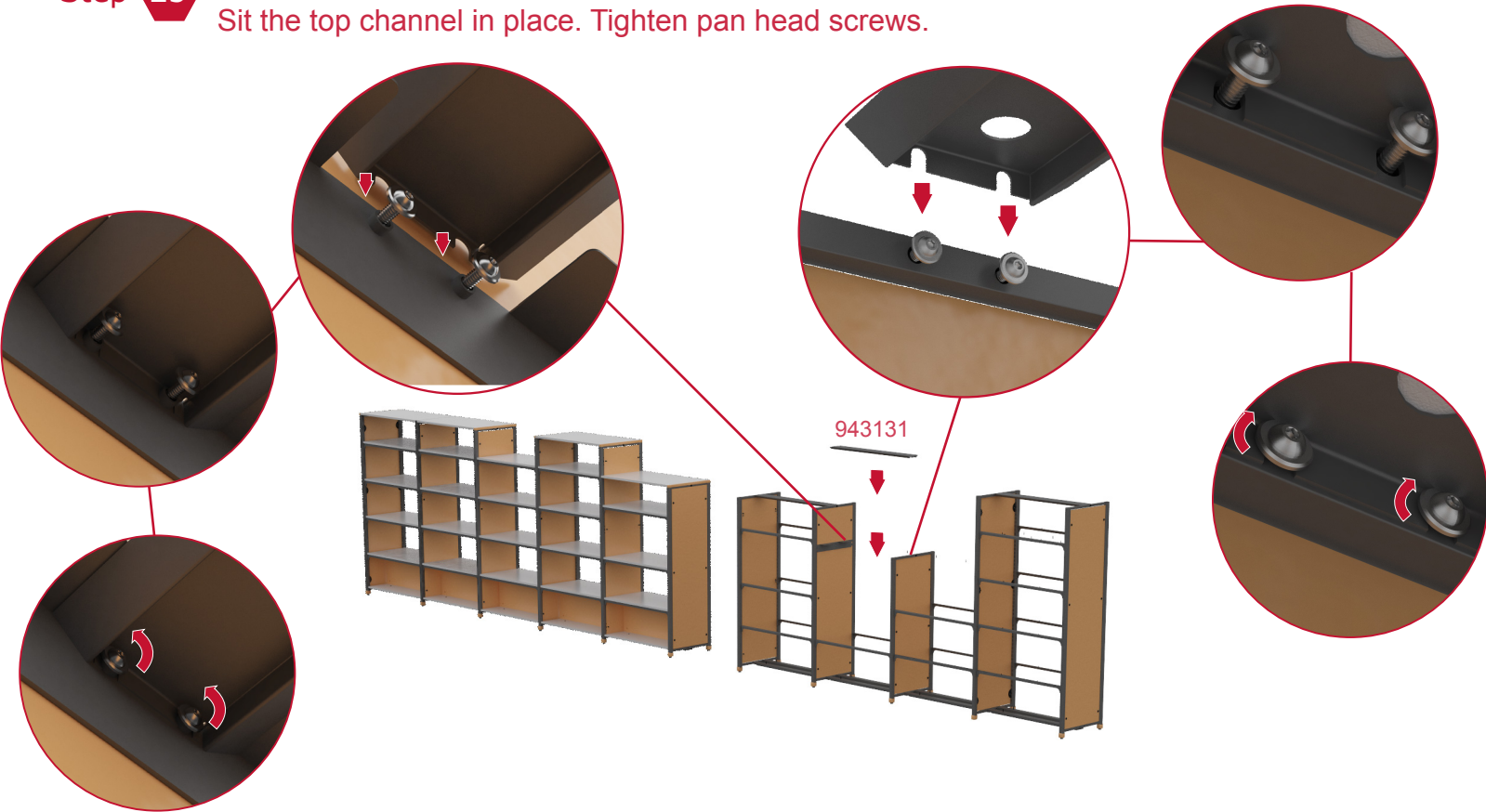

Step 26 Line up the bottom shelves with the four predrilled holes with the tinnerman nuts in bottom channel. Attach using four allen head bolts.

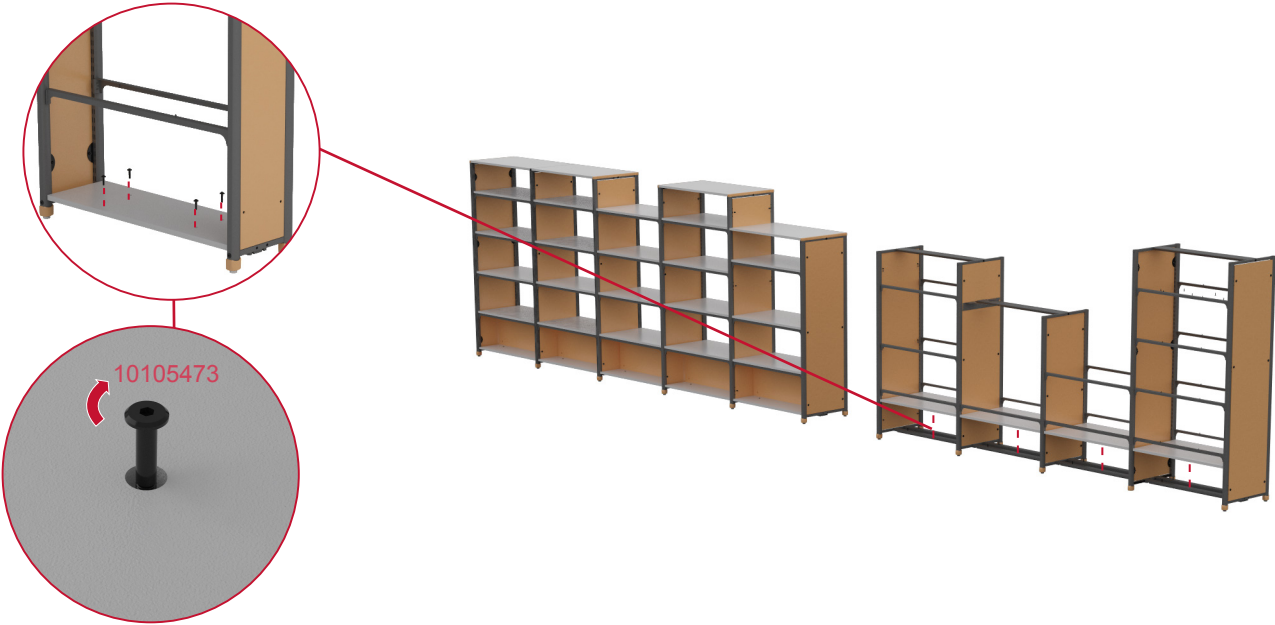

Step 27 Slide dividers into studs as shown.

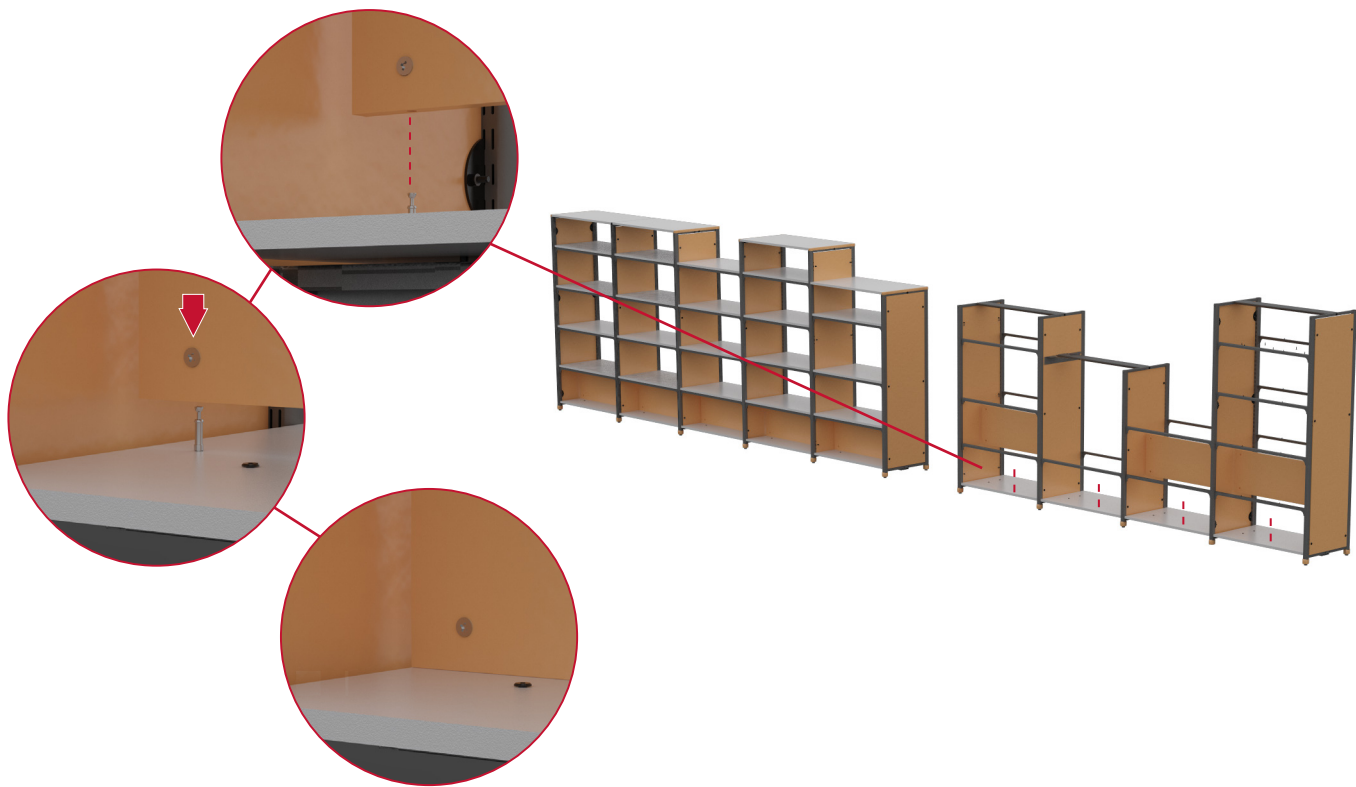

Step 28 Place side book stops on adjustable center shelf using 2 wood screws on each.

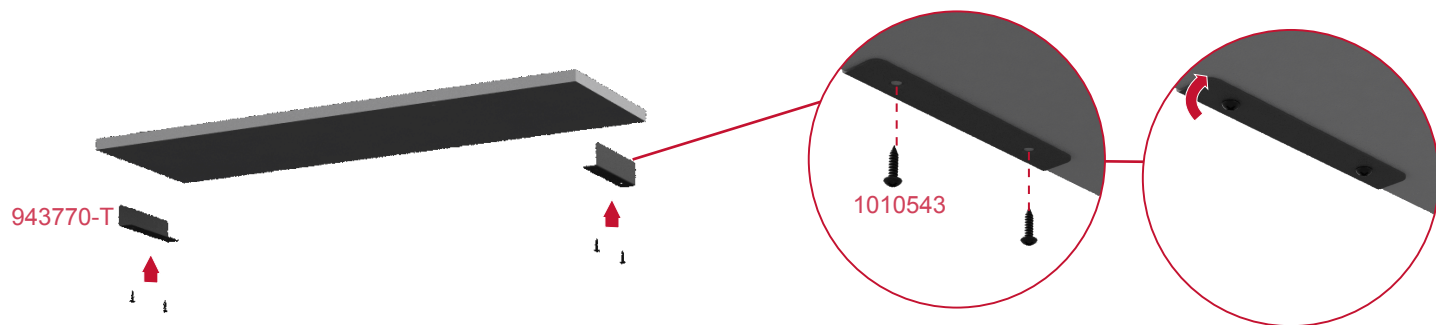

NOTE 2 Side book stops on single face units. 4 Side book stops on double face units

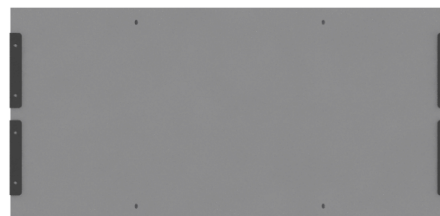

Step 29

Place center shelves in on top of brackets lining up guide pegs and holes and secure the shelf to the bracket with 6 wood screws in center edge of each shelf.

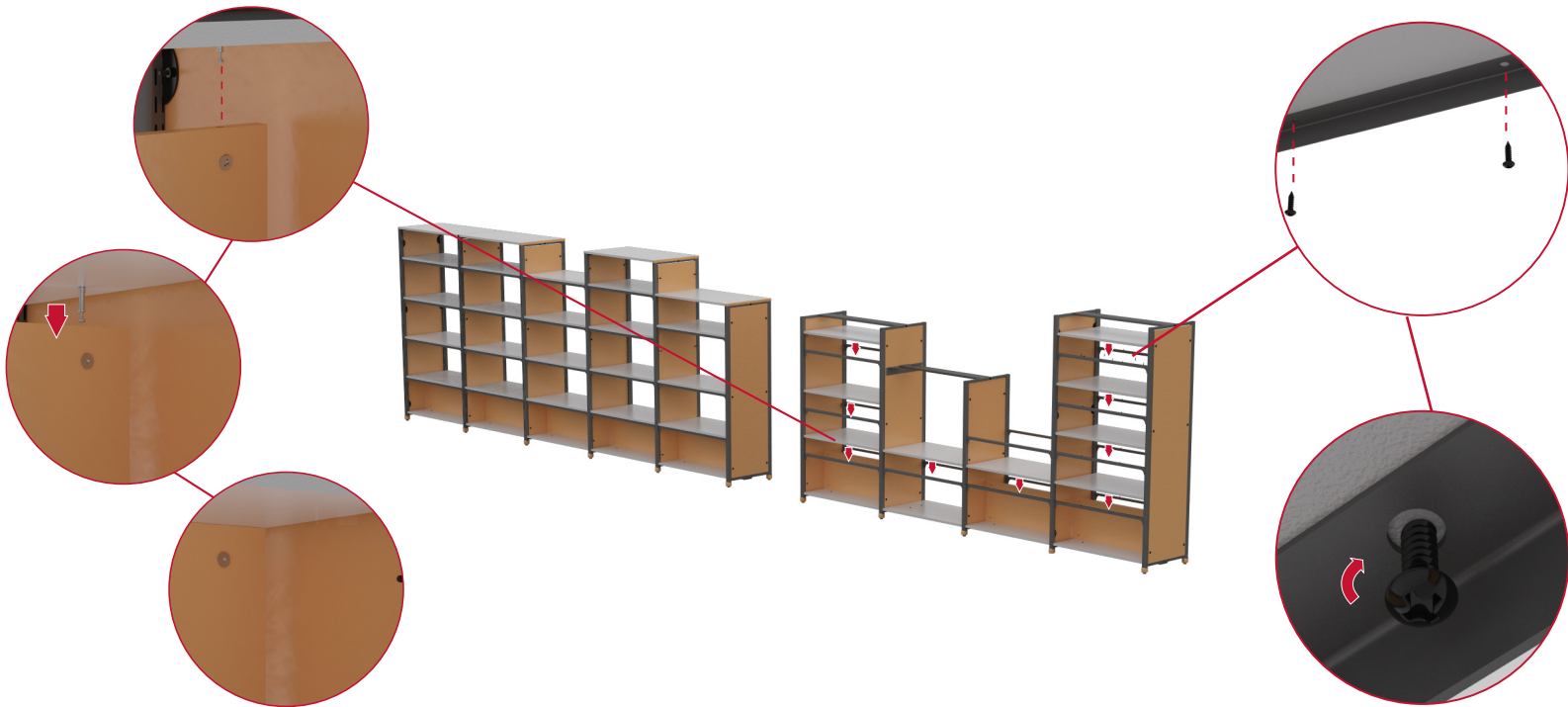

Step 30

Place end caps in place.

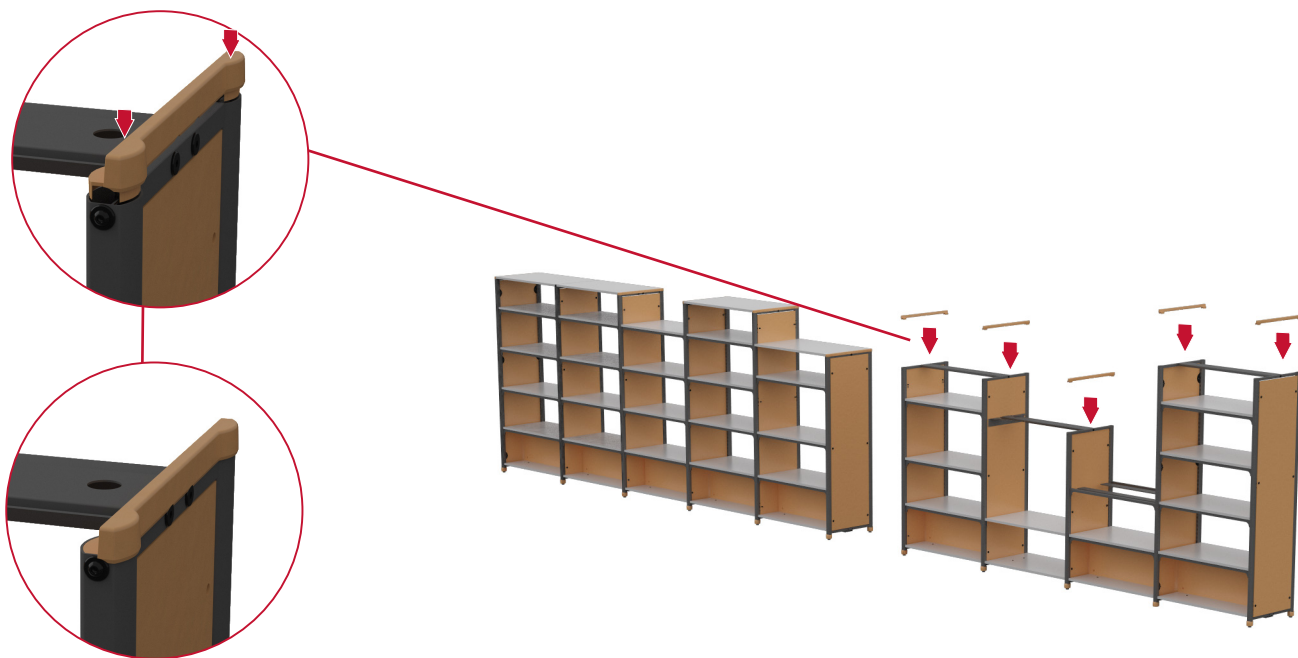

Step **31** Place top shelves on top of the top channels.

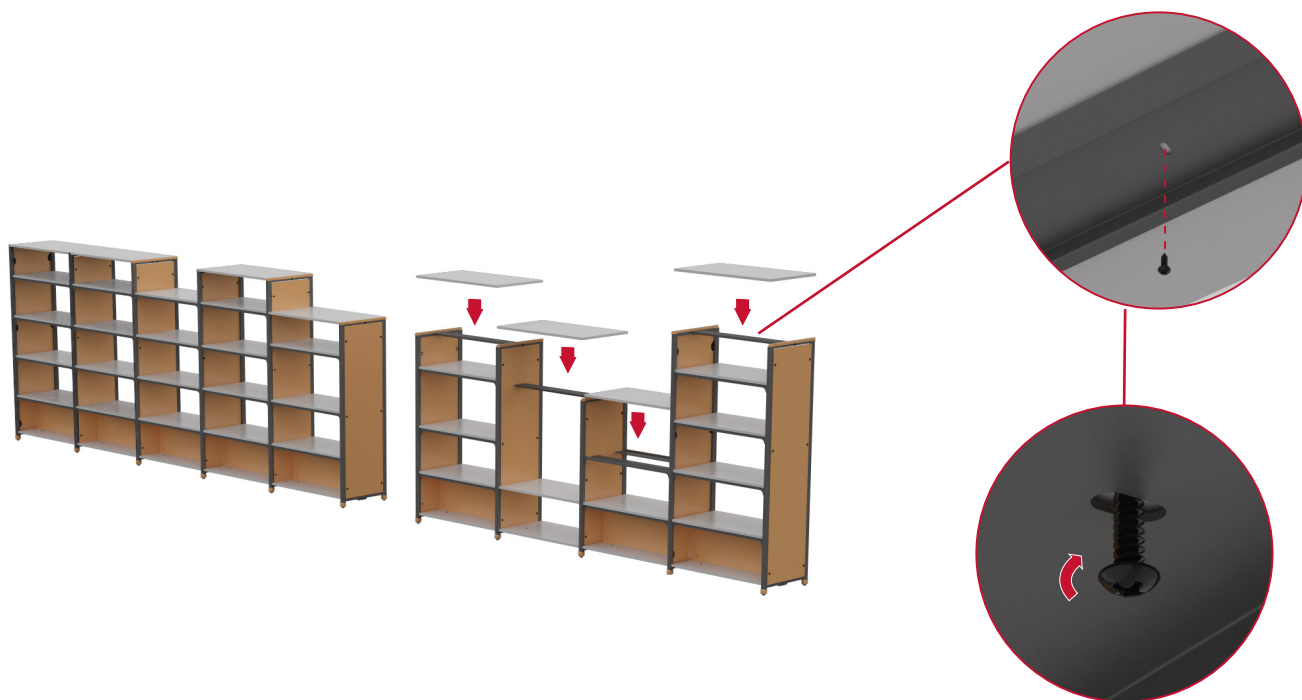

Step **33** Building In Run Bench
 Sit bottom shelf support channel. Tighten pan head screws.

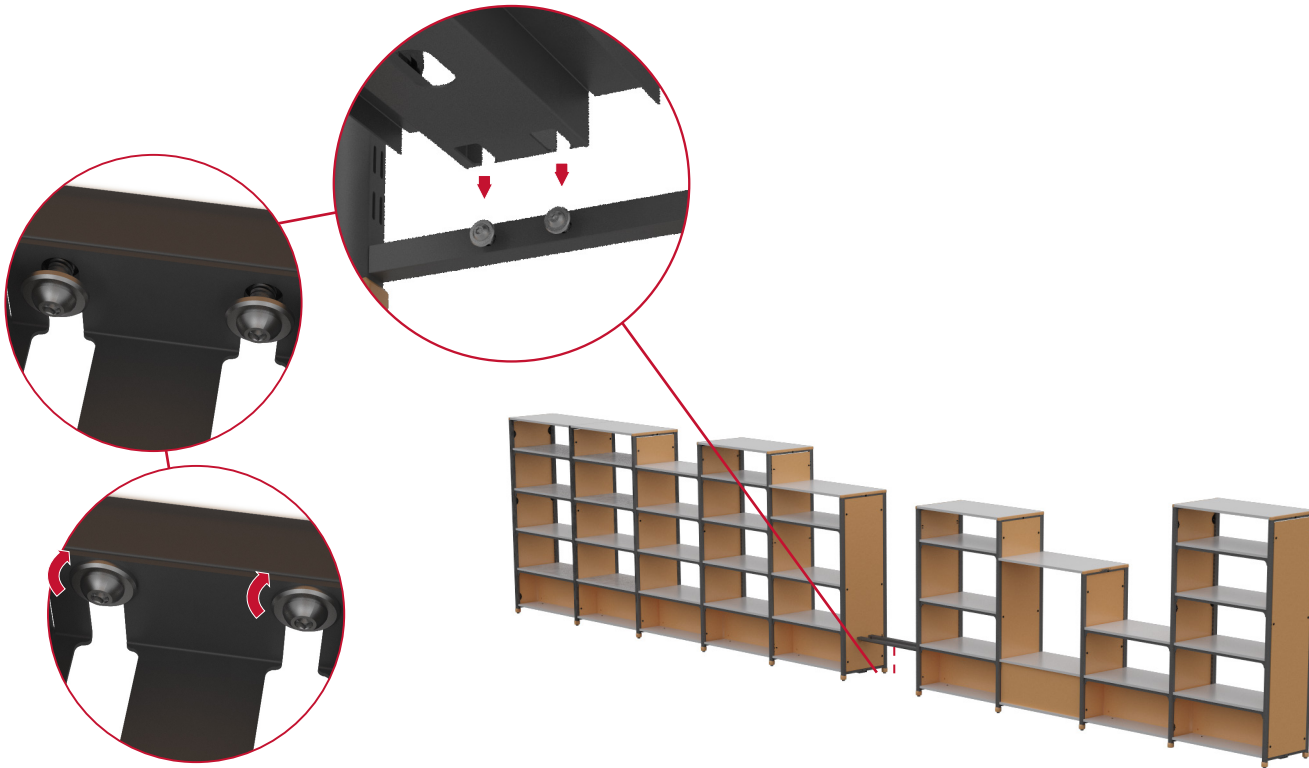

Step **34** Line up the bottom shelf with the four predrilled holes with the tinnerman nuts in bottom channel. Attach using four allen head bolts.

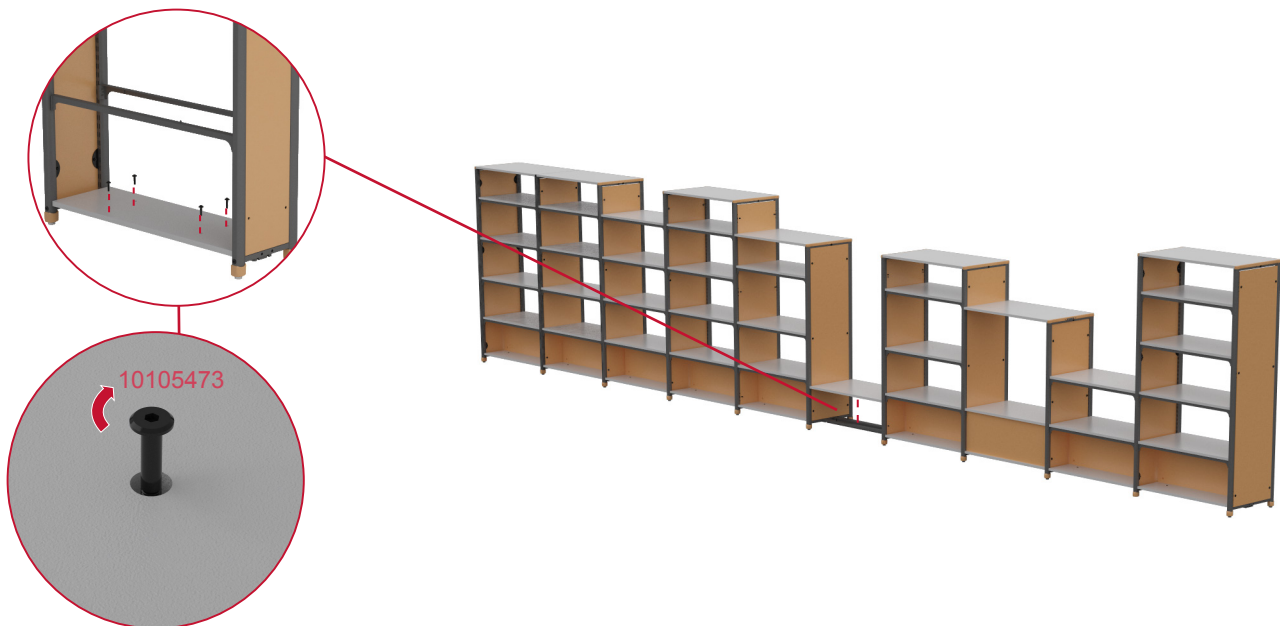

Step 35 Slide dividers.

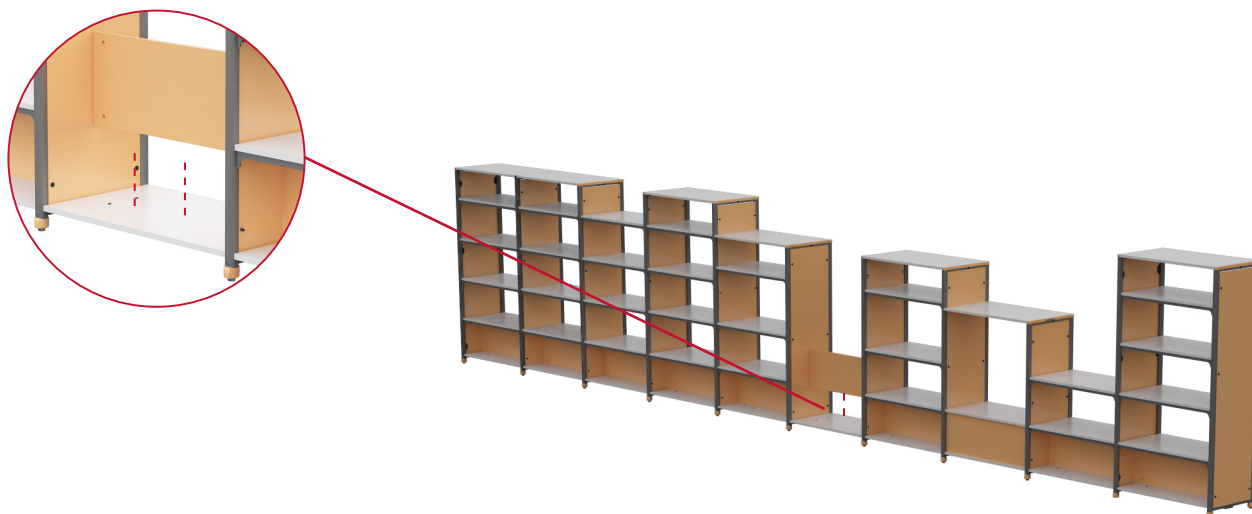

Step 36 Place easy lock cushion bracket on back cushions using four wood screws.

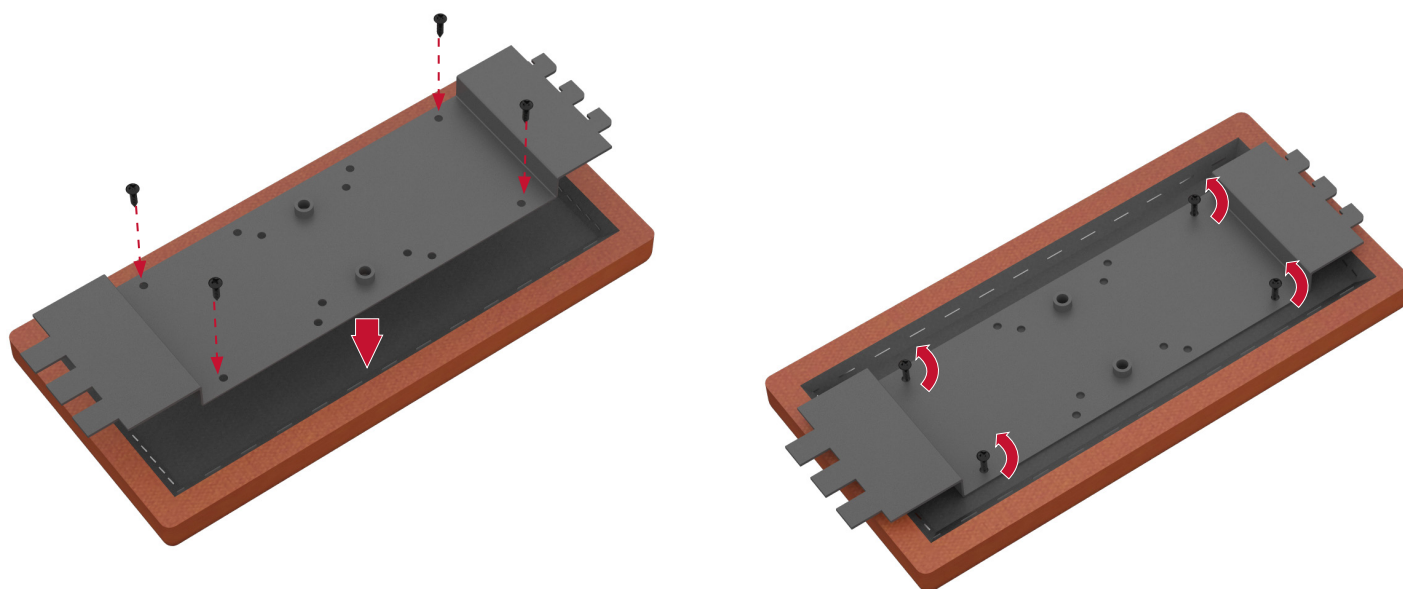

Step 37 Place back cushions in place.



Step 38 Slide two horizontal shelf brackets in place

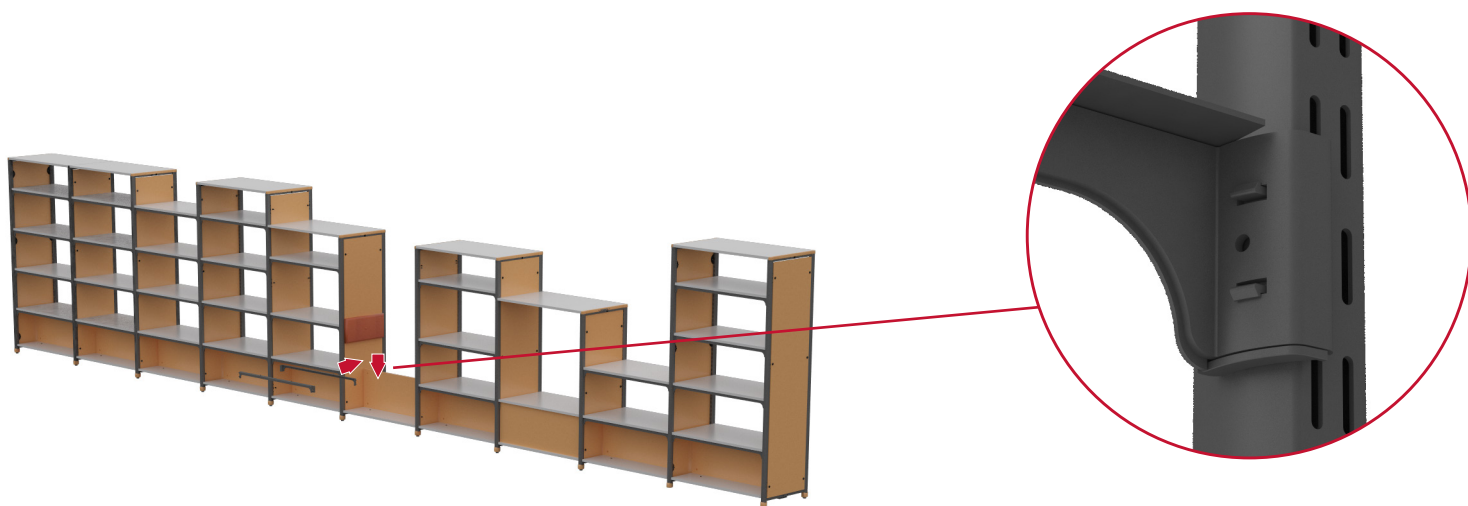

Step 39 Place bench on shelf brackets.

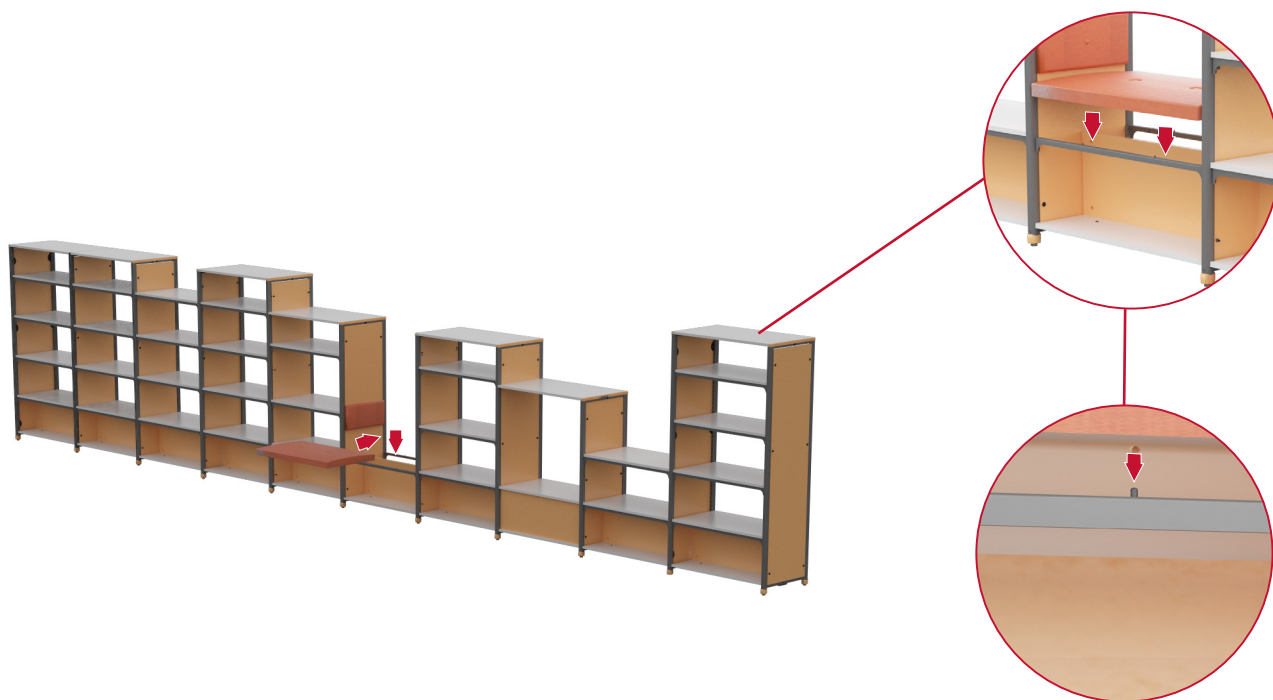

Step 40 In Run Table

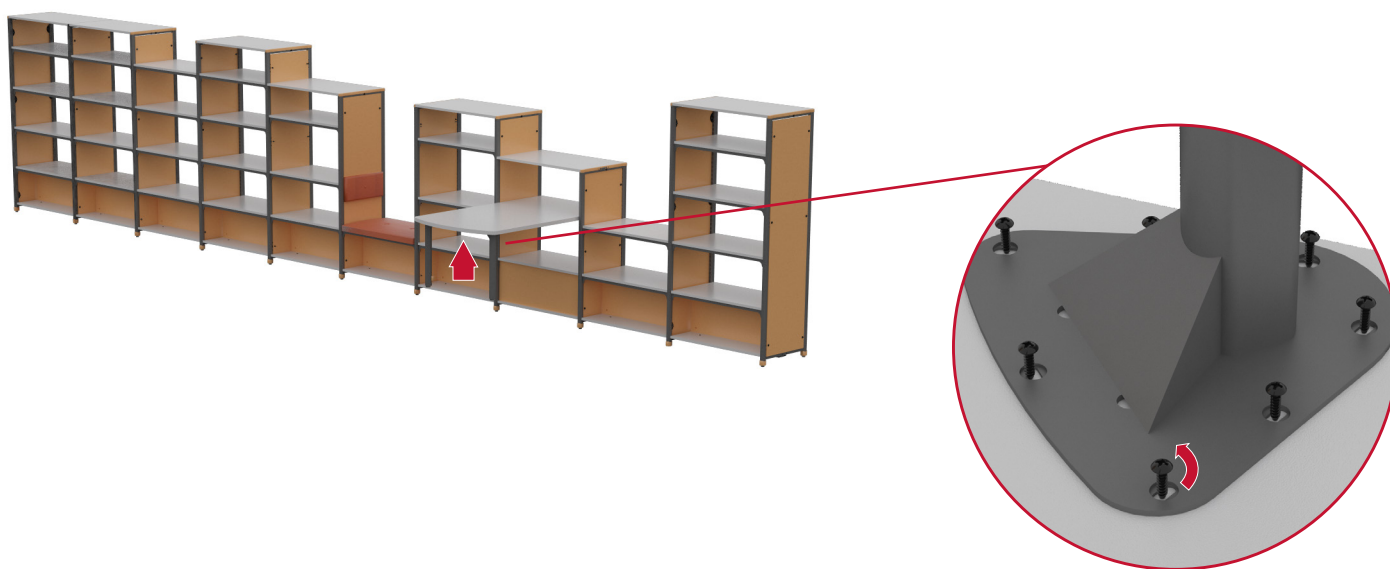

Step 41 In Run Table

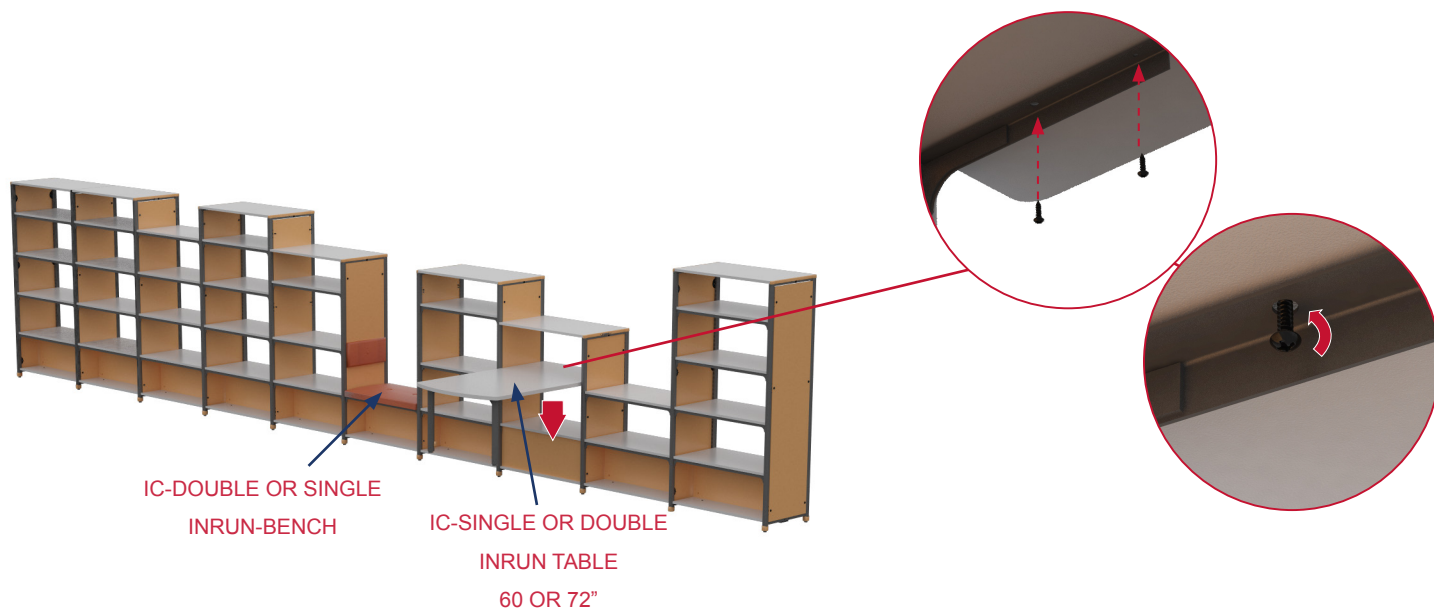

Step 42 Install book wires.



Insert book wires.



Press it tight with your hand.

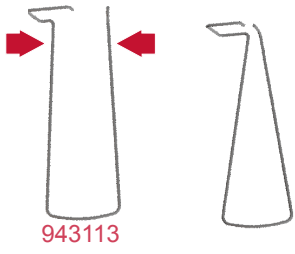

943113

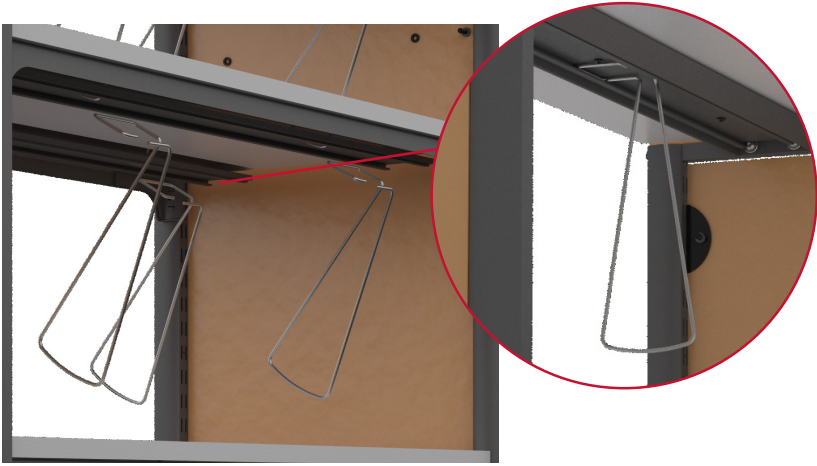

Step 43 End Of Run Tables.

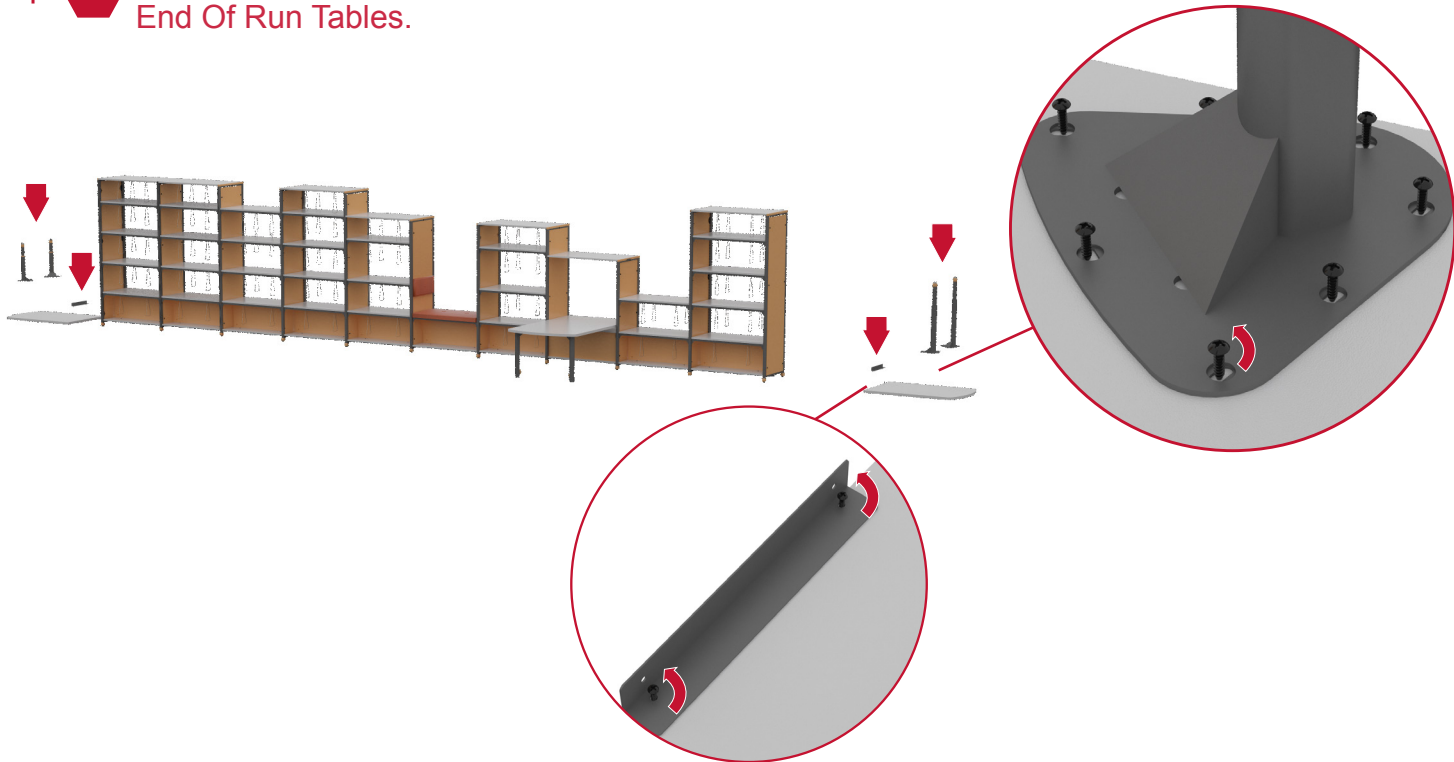

Step 44 End Of Run Tables.

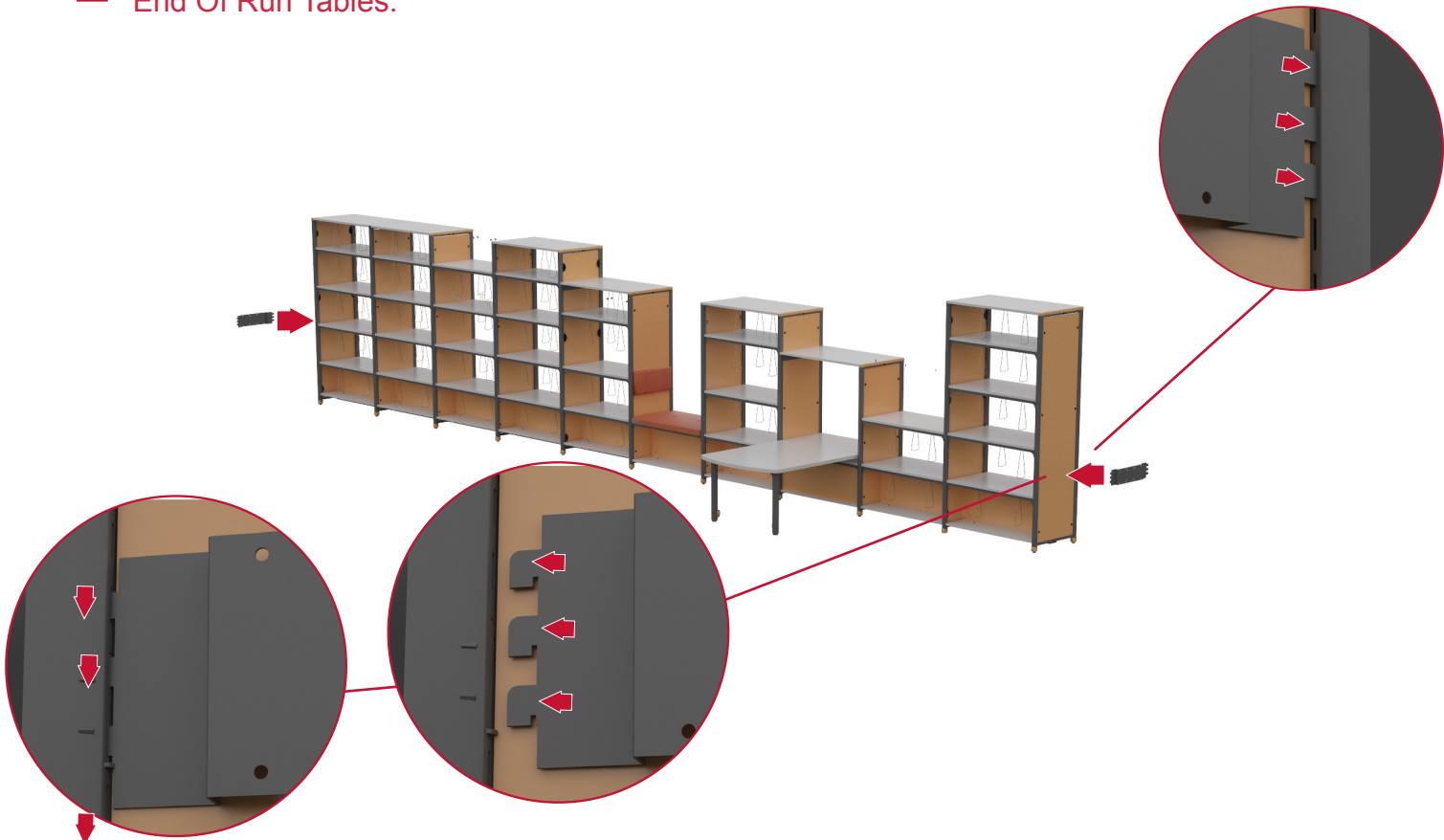

Step 45 End Of Run Tables.

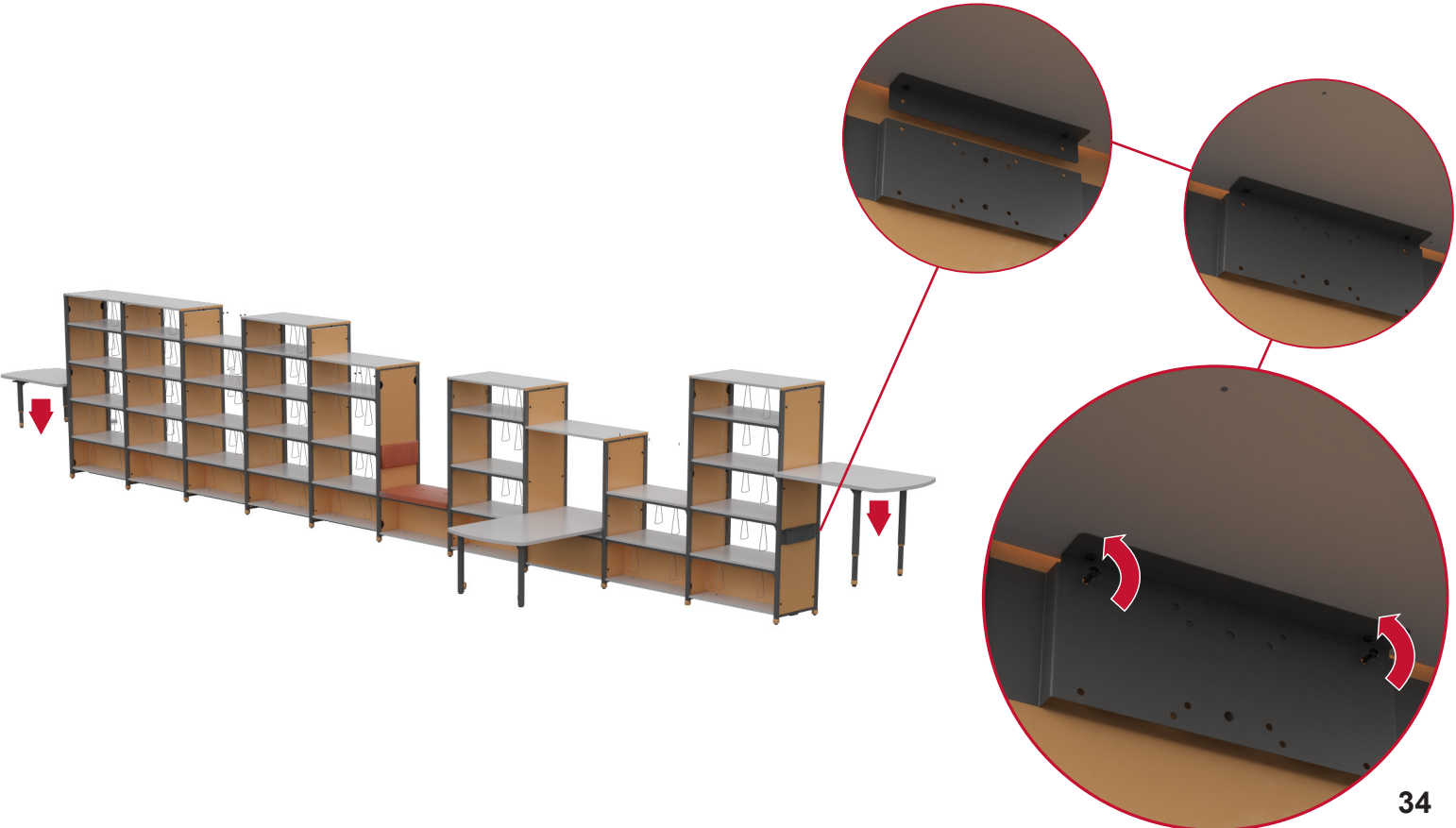



Step 46 Wall Attachment.

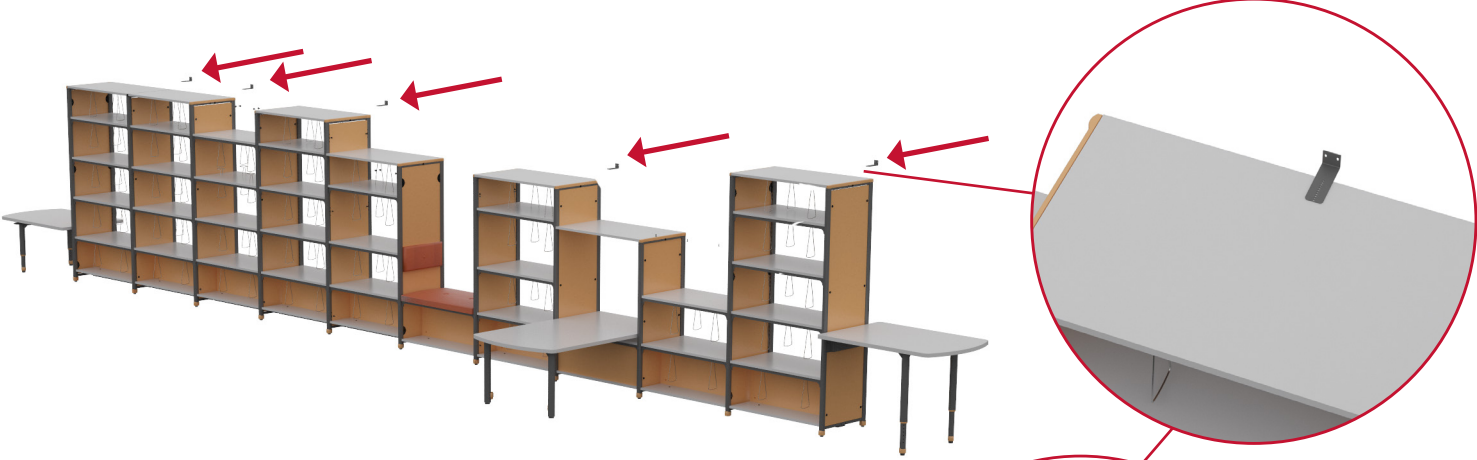

NOTE
Floor attaching hardware is not included.
See page 37 for California Building code.



Step 47 Floor Attachment.

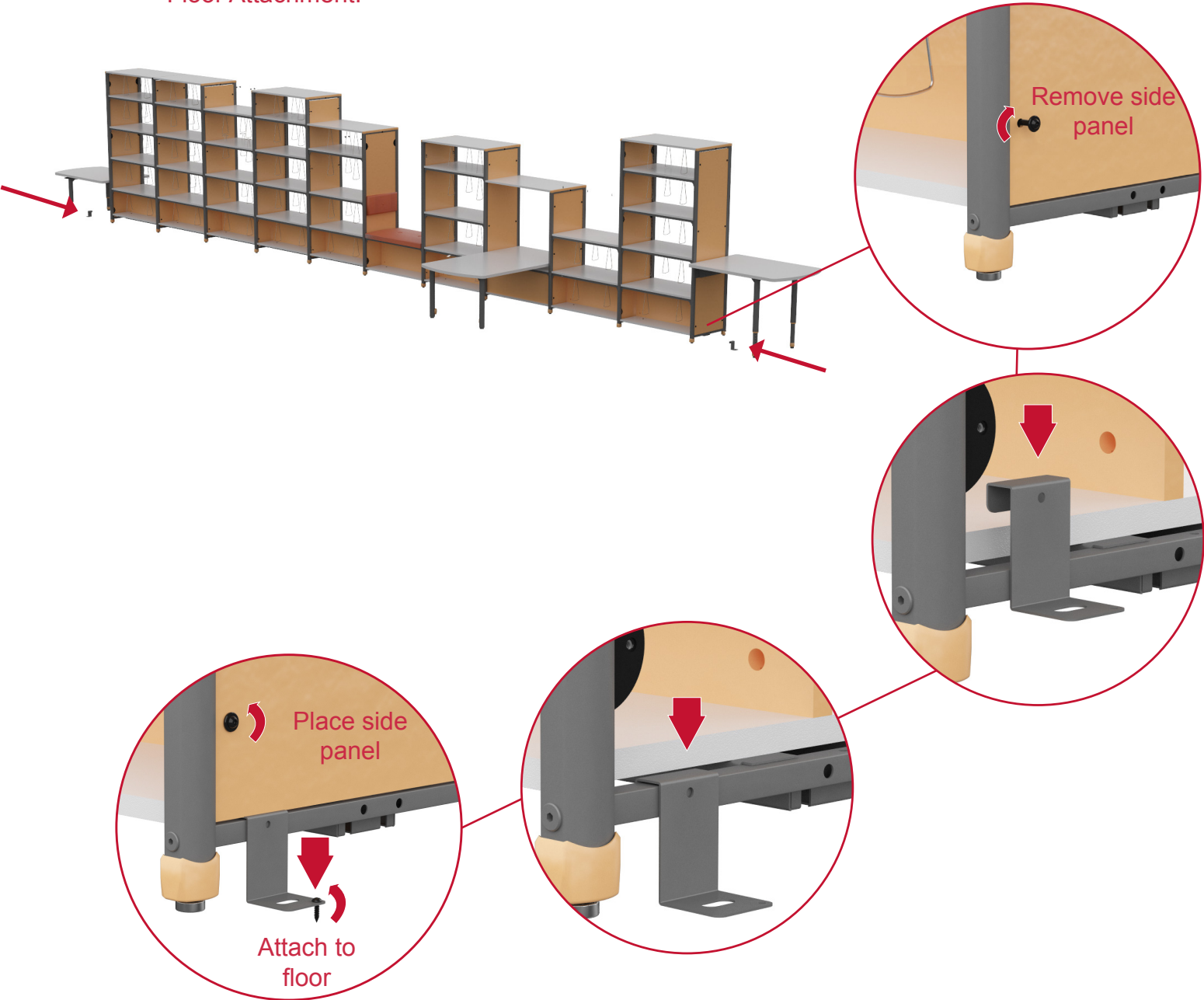

NOTE
Floor attaching hardware is not included.
See page 37 for California Building code.



June
2011

SEISMIC STANDARDS/INSTALLATION

FURNITURE/STEEL CABINETS

Steel Cabinets (Storage and wardrobe) meet California Administrative Code Title 24, Part 2, Section 2-2312, (Earthquake safety) seismic standards, if installed per manufacturer's instructions.

Installation is the responsibility of the purchaser. Installation hardware is included with each unit.

In accordance with the California Administrative Code, Title 24, State Building Code, Part 2, Section 2-2312, **Earthquake Safety, all:**

"Storage racks with the upper storage level more than 5 feet in height (plus contents);"...

"Floor supported cabinets and book shelves more than 5 feet in height (plus contents);"...

"Wall hung cabinets and storage shelves (plus contents); **must be designed, constructed and anchored in such a manner as to resist stresses and limit deflections caused by earthquake forces.**"

Prior to use of the shelving system, cabinets, etc., the structure must be anchored in accordance with drawings supplied by the manufacturer.

Local agencies should check with their governing bodies to determine if compliance with UBC/CAC is required.

INDUSTRIAL SHELVING

California Administrative Code Title 24, State Building Code 2, Part 2 (CAC 24, SBC 2), requires that industrial steel shelving be designed, assembled and anchored so as to resist seismic forces when fully loaded.

The industrial steel shelving components manufactured by CALPIA when assembled and anchored as prescribed by CALPIA are certified by the Office of the State Architect (OSA) to be compliant with CAC 24, SBC Part 2.

Any other sizes, configurations, anchorages, etc., that the end user may wish to order shall require additional calculations, prepared and signed by a California licensed structural or civil engineer substantiating compliance of the shelving installation to the California Administrative Code. These calculations shall be the responsibility of the end user.